

# B24 Telemetry User Manual

mantracourt.com



## B24

Bluetooth Telemetry System

|  |           |
|--|-----------|
| <b>Introduction / Overview</b> .....                           | <b>4</b>  |
| Advertising Operation.....                                     | 4         |
| Connected Operation.....                                       | 5         |
| <b>Navigating This Manual</b> .....                            | <b>6</b>  |
| <b>Product Quick Locator</b> .....                             | <b>6</b>  |
| <b>B24 Telemetry Basic Principles</b> .....                    | <b>7</b>  |
| Transmission Range.....  | 7         |
| Sensitivity Range.....   | 7         |
| Data rate.....   | 7         |
| Resolution.....  | 7         |
| Transmitter Module Modes of Operation.....                     | 7         |
| Data Tag.....  | 7         |
| <b>B24 Toolkit App</b> .....                                   | <b>8</b>  |
| Splash Screen.....   | 9         |
| Project List.....  | 10        |
| Project List Edit.....   | 11        |
| Main Menu.....   | 12        |
| Import Project.....  | 13        |
| New Project.....   | 14        |
| Edit Project.....  | 15        |
| Linked Transmitters.....                                       | 17        |
| Add Transmitter.....   | 19        |
| Find Transmitters.....   | 20        |
| Edit Transmitter.....  | 21        |
| Project Dashboard Blank.....                                   | 23        |
| Dashboard Add Tile.....  | 24        |
| Project Dashboard Populated Example.....                       | 27        |
| Project Dashboard Edit Mode.....                               | 29        |
| Metric Tile.....   | 31        |
| Indicator Tile.....  | 33        |
| Gauge Tile.....  | 35        |
| Tank Tile.....   | 37        |
| Chart Tile.....  | 39        |
| Expression Editor.....   | 41        |
| Functions, Constants and Operators for Use in Expressions..... | 46        |
| Unit Conversions.....  | 48        |
| Error Bar.....   | 51        |
| Icon List.....   | 52        |
| Configure Transmitter.....                                     | 53        |
| Configuration Identification.....                              | 55        |
| Configuration Measurement.....                                 | 57        |
| Calibration Locked.....  | 59        |
| Configuration Calibration Auto Calibration.....                | 60        |
| Configuration Calibration Table Cal.....                       | 63        |
| <b>Transmitter Modules</b> .....                               | <b>65</b> |
| B24-SSBX-A, B24-SSBC-A.....                                    | 65        |
| Overview.....  | 65        |
| Order Codes.....   | 65        |
| B24-SSBX-A.....  | 65        |
| B24-SSBC-A.....  | 65        |
| Connections.....   | 66        |
| B24-SSBX-A.....  | 66        |
| Power.....   | 66        |
| Sensor.....  | 66        |
| Digital Connections.....                                       | 67        |
| Reset Communications.....                                      | 67        |

|  |           |
|--|-----------|
| B24-SSBC-A.....  | 68        |
| Power.....   | 68        |
| Sensor.....  | 68        |
| Enclosure & Mounting.....                                  | 69        |
| B24-SSBX-A.....  | 69        |
| B24-SSBC-A.....  | 69        |
| Antennas.....  | 69        |
| B24-SSBX-A, B24-SSBC-A.....                                | 69        |
| Specification.....   | 70        |
| <b>Power Supply Modules.....</b>                           | <b>71</b> |
| T24-BC1.....   | 71        |
| Overview.....  | 71        |
| Physical Connections.....                                  | 71        |
| Specification.....   | 71        |
| <b>Appendices.....</b>                                     | <b>72</b> |
| Appendix A - Enclosures.....                               | 72        |
| OEM Transmitter Modules.....                               | 72        |
| Dimensions.....  | 72        |
| Opening the Case.....                                      | 72        |
| Mounting Information.....                                  | 72        |
| Antenna Position.....                                      | 73        |
| Environmental Protection.....                              | 73        |
| 'C' Type.....  | 74        |
| Dimensions.....  | 74        |
| Opening the Case.....                                      | 74        |
| Mounting Information.....                                  | 74        |
| Antenna Position.....                                      | 75        |
| Environmental Protection.....                              | 75        |
| Appendix B – Antennas.....                                 | 76        |
| B24-SSBX-A, B24-SSBC-A.....                                | 76        |
| Internal Chip Antenna (OEM Modules).....                   | 77        |
| Mounting.....  | 77        |
| Antenna Range.....   | 78        |
| Appendix C - Radio Specification.....                      | 79        |
| Bluetooth certification.....                               | 79        |
| Appendix D – Battery Selection.....                        | 80        |
| Considerations When Selecting Batteries.....               | 80        |
| Re-chargeable or replacement.....                          | 80        |
| Required battery life.....                                 | 80        |
| Size of.....   | 80        |
| Operating temperature range.....                           | 80        |
| Self-discharge.....  | 80        |
| Connections to battery.....                                | 80        |
| Environmental.....   | 80        |
| Optimising battery life.....                               | 81        |
| Battery Types.....   | 82        |
| Battery Life Guide.....                                    | 83        |
| Appendix E – Approval Statements.....                      | 83        |
| Certifications.....  | 84        |
| CE Certification.....                                      | 84        |
| CE certification for SPBTLE-RF module.....                 | 85        |
| FCC Certification.....                                     | 85        |
| FCC Modular approval.....                                  | 85        |
| IC Certification.....                                      | 85        |
| IC Modular approval.....                                   | 86        |
| OEM / Reseller Marking and Documentation Requirements..... | 86        |

|   |    |
|---|----|
| CE Labelling Instructions.....                  | 86 |
| FCC Labeling Instructions.....                  | 86 |
| FCC Product Manual Instructions.....            | 87 |
| IC Labeling Instructions.....                   | 87 |
| IC Product Manual Instructions.....             | 88 |
| Appendix G - Worldwide Regional Approvals ..... | 89 |
| Important Note .....                            | 89 |
| Appendix H - Declaration of Conformity .....    | 90 |
| Appendix I - Warranty.....                      | 91 |

---

## Introduction / Overview

The B24 Bluetooth Telemetry range provides access to quality measurements on a mobile platform such as a phone or tablet. The delivery mechanism is 'Bluetooth Low Energy' (Also known as 'Bluetooth Smart' or BLE) which utilises the flexibility and availability of Bluetooth receivers while maintaining the low power requirements of embedded systems. B24 is built upon two complimentary principles of BLE, broadcast advertising data which enables users to deliver the same data to multiple receivers simultaneously and low power connections which can be used in a point to point system. B24 is available in OEM bare board formats and with environmentally sealed enclosure with integrated battery holder.

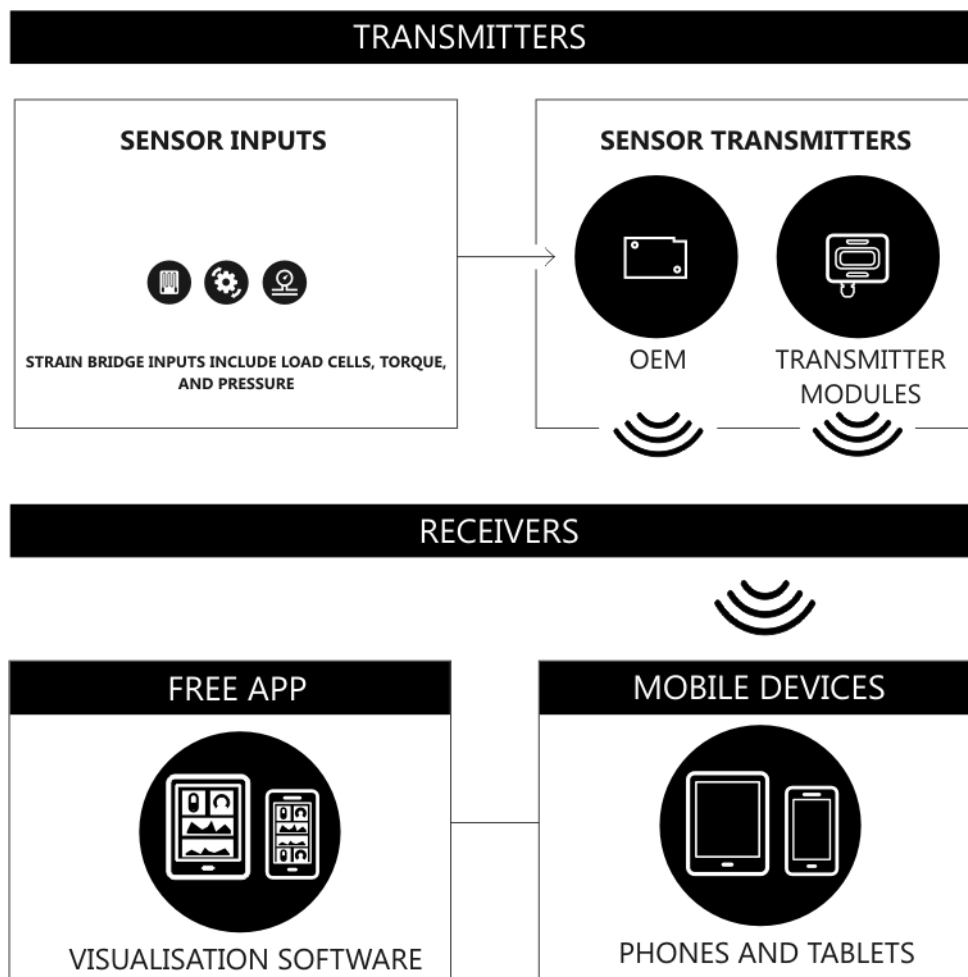

This manual provides details of using B24 modules with the free Android and iOS apps for mobile phones and tablets.

---

## Advertising Operation

The advertising mode of operation enables B24 modules to broadcast measurement data to multiple locations without retransmission. The advert is an operational mode within 'Bluetooth Low Energy' and facilitates the delivery of data without a connection. This mode of operation is useful in 'many to many' and 'one to many' use cases.

This mode is used by the free apps to display live data on their dashboards where one or many B24 modules can supply live data to one or more Android or iOS tablets and phones.

---

## Connected Operation

The connected operational mode enables Bluetooth Low Energy devices to connect directly to the B24 module. A single mobile device can be connected to multiple B24 transmitter modules simultaneously. This mode has a dual purpose as it may be used monitor data and configure the device. When it is used for the delivery of data the application can register to receive notification updates when the status and engineering unit value changes. This mode of operation is useful in 'one to one' and 'many to one' use cases.

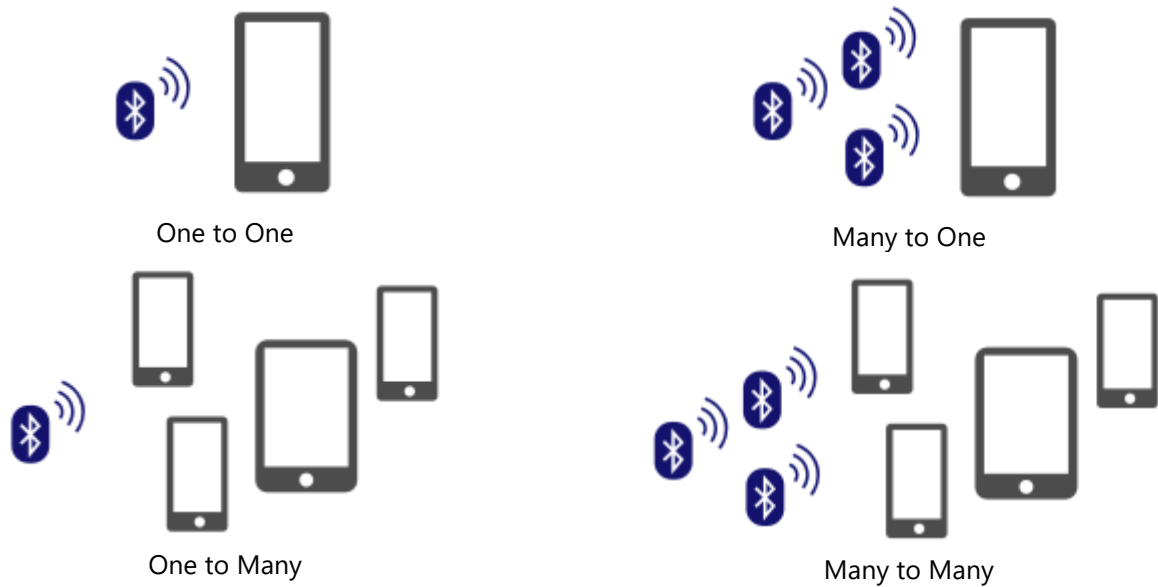

This mode is used in the free app to connect to an individual module for configuration.



---

## Navigating This Manual

When viewing this PDF manual the following tips will help you navigate.

Viewing bookmarks ( or ) to the left of the page, in the PDF viewer, will allow easy navigation to the relevant chapters of this manual. Alt-left arrow is a useful shortcut back to the last page viewed after a hyperlink is clicked. Hyperlinks are coloured green and are underlined.

---

## Product Quick Locator

This section allows you to locate your product quickly to navigate to the correct section of the manual.

### **Strain Input**

[B24-SSBX-A](#)

[B24-SSBC-A](#)

[T24-BC1](#)

---

## B24 Telemetry Basic Principles

There are some basic radio settings and concepts that should be understood to effectively configure, deploy, optimise and troubleshoot B24 telemetry systems.

---

### Transmission Range

The flexibility of the B24 range is that the user may utilise their mobile phone rather than using a specific handheld receiver or base station. This flexibility does mean that Mantracourt has no control over the quality of the receiver. This imparts a large variation in the transmission range capability of the module.

---

### Sensitivity Range

The input sensitivity range is designed for bridge based sensors and is configurable between  $\pm 6$  mV/V and  $\pm 48$  mV/V. This flexibility allows us to provide solutions for a wider range of strain gauge types.

---

### Data rate

The Bluetooth specification specifies the maximum rate at which advertisement information can be delivered. The B24 module may be configured to deliver data in the range between 10 samples per second and 1 every 10 seconds.

---

### Resolution

The noise free resolution of the B24-SSB is up to 16.5 bits. This is equivalent to 1 in 92000 counts.

---

### Transmitter Module Modes of Operation

The B24 module disconnects the power from the load cell and sleeps the micro-controller in between measurements. This improves the battery lifetime of the system a makes the most efficient use of the battery's energy. There are no automatic sleep or wake functions, the modules have been designed to be 'set and forget' so transmit all of the time.

---

### Data Tag

The advertising packets transmitted by B24 modules are identified by their Data Tag. The Data Tag is a four character hexadecimal identifier that will be either printed on the modules silver enclosure label, or in the case of an OEM module, it is the last 4 characters of the modules hexadecimal serial number (Yellow). The Data Tag can be changed by configuring the module.

Because multiple receivers, such as apps or custom software, may be configured to use data identified by certain Data Tags, the ability to change them in a module means that it is very simple to replace a module without reconfiguring multiple receivers.



# B24 Toolkit App

The B24 Toolkit App is available for iOS (V10.0 and above) and Android (V5.0 and above) devices and is available for free from the App Store and Google Play store.

**i** Use the QR codes below to access the app in the store or tap the store banner if you are viewing this document on your device.

## Google Play Store



## Apple App Store



**i** This app requires access to the Bluetooth Services which are part of Location Services so the user may need to grant permission for the app to access Location even though the app does not use any location data.

The App allows the user to create multiple Projects. Each project can contain a list of defined Transmitter Sources which are B24 modules.

Each project has a Dashboard which can be populated with display Tiles that use data from the Transmitter Sources to represent values in different formats.

When in run mode the App uses the data from the B24 module to populate the dashboard Tiles in real time.

The App will also support one to one connections with the B24 modules to enable configuration and calibration.

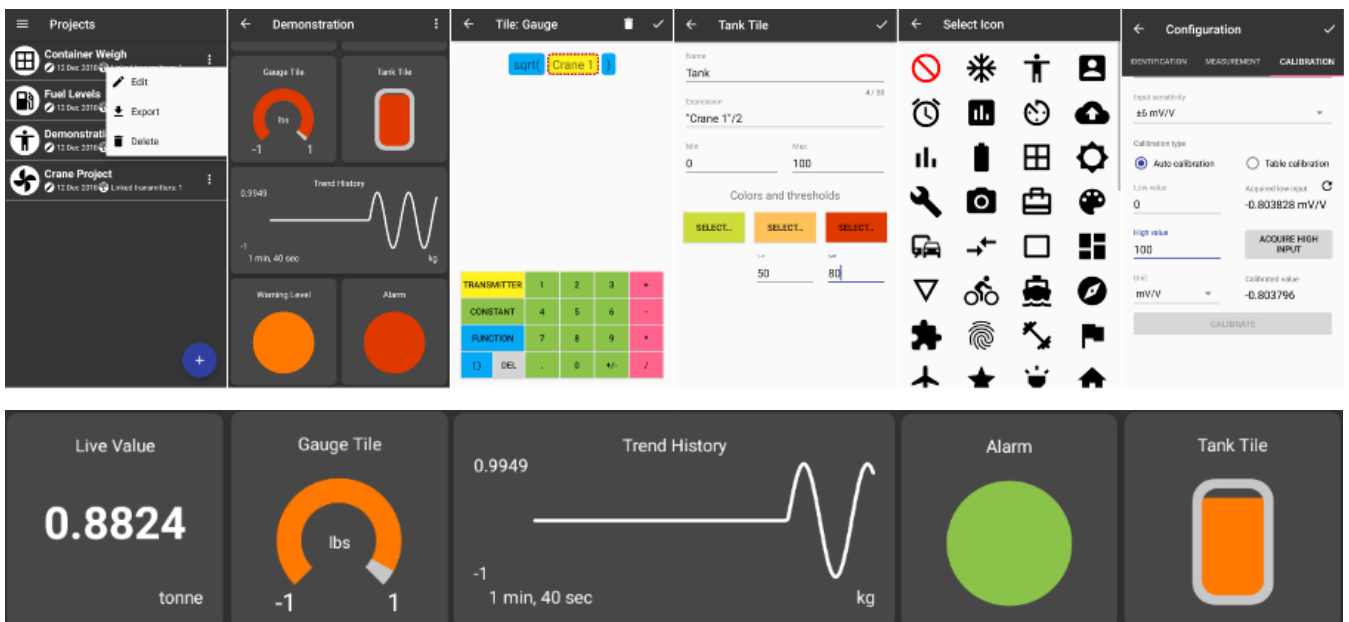

---

## Splash Screen

On launching the app the splash screen will be displayed.

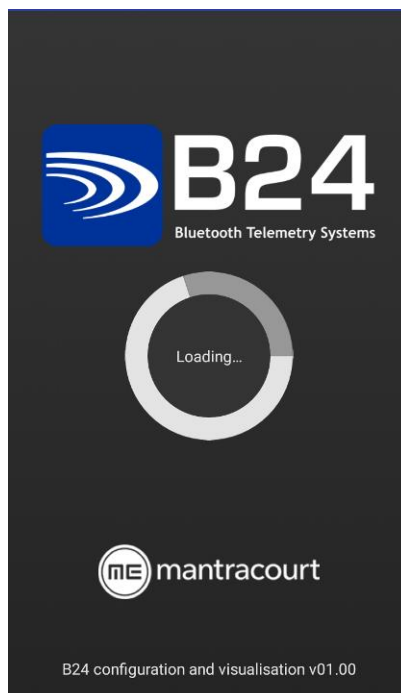

This displays the app version number at the bottom of the screen.

# Project List

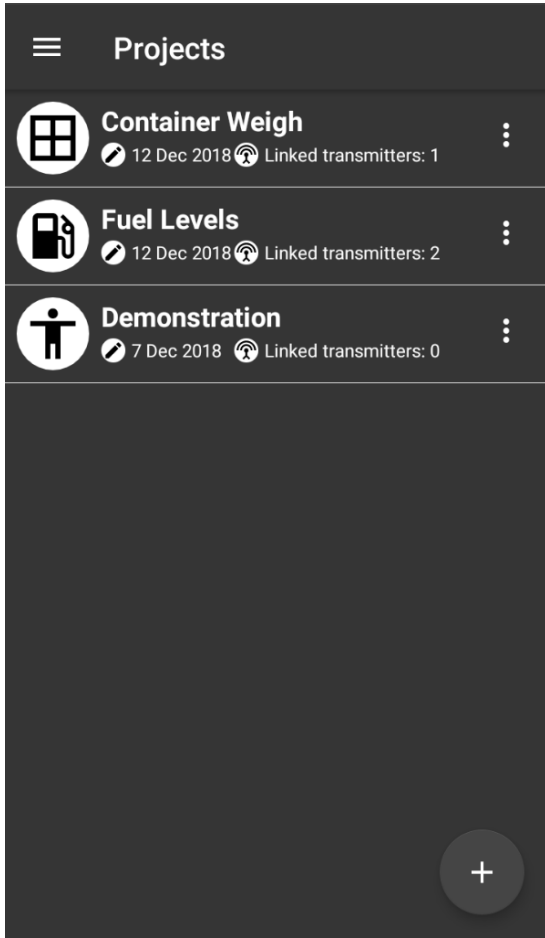

Android

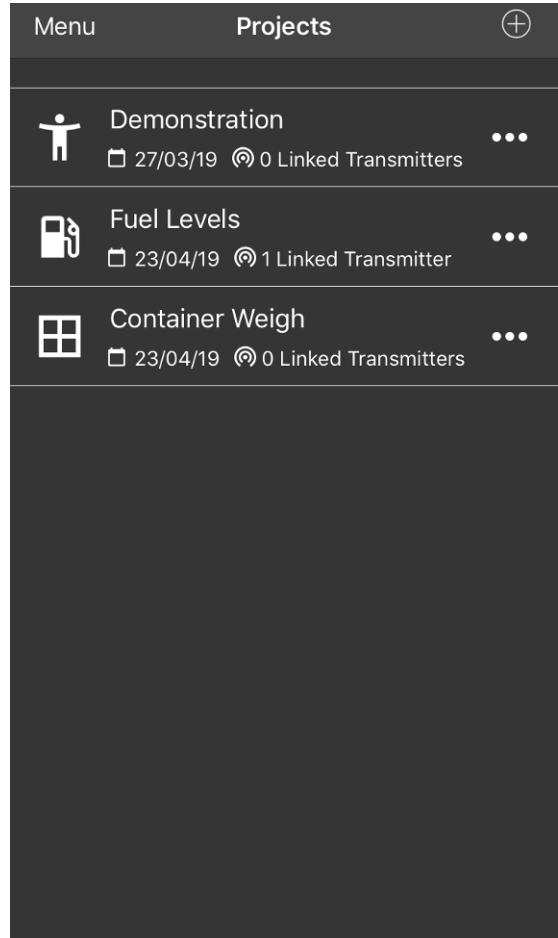

iOS

The first page that appears after the Splash Screen is the Project List. This contains a scrollable list of all existing projects. The number of projects you can add will be limited only by the memory of the phone or tablet. Next to the user selectable icon the project title is shown and below is shown the date of the last change to the project and the number of transmitters in that project.

After initial app installation the list will contain a single project called Demonstration.

Once you create your own project and delete the demonstration project (so only one project exists), on next launching the app the project list will be skipped and the project dashboard will be displayed.

### Controls and Actions:

x / Menu

Main Menu – See [Main Menu](#) section. From this menu you can import a project and configure transmitters.

V / I

Add Project – adds a new project to the list. See [New Project](#) page

u / J

Menu – opens the options for each project to allow editing, export and deletion of the project. See [Project List Edit](#) page.

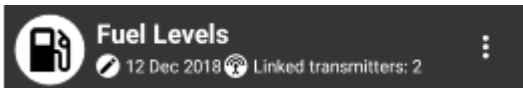

Tapping on a project item in the list will open that project in Dashboard View. If no tiles have been added yet then the dashboard will be blank. See [Project Dashboard Blank](#) page. Otherwise the dashboard will be displayed with tiles visible. See [Project Dashboard Example](#) page.

## Project List Edit

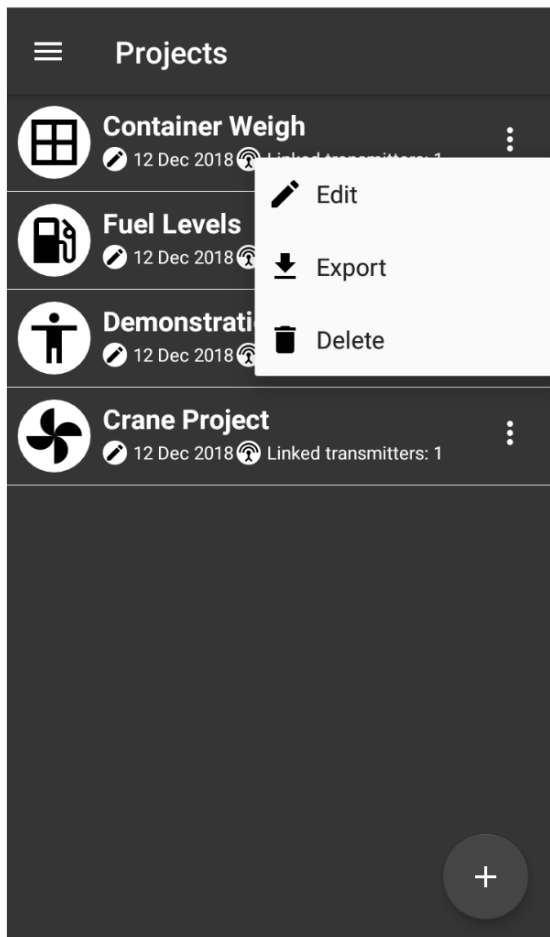

Android

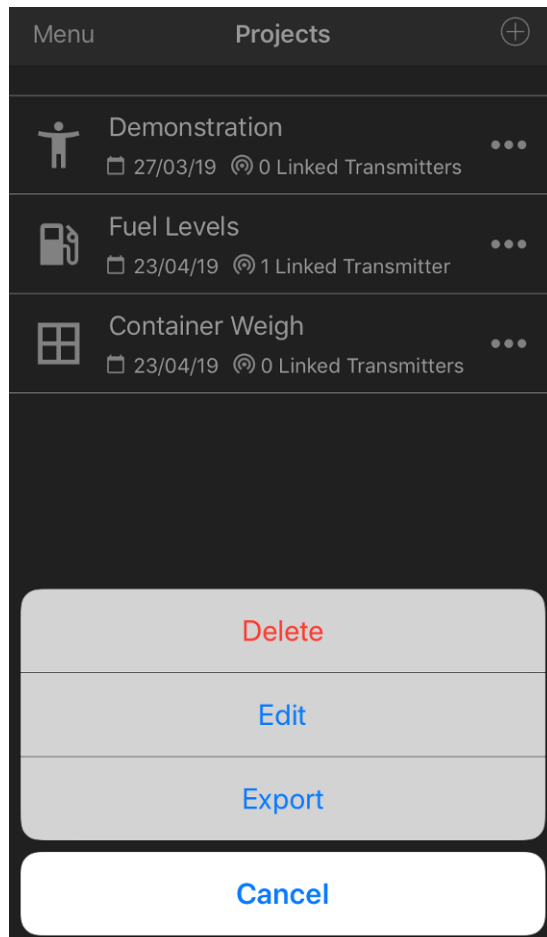

iOS

Tapping the menu icon next to a project opens the project menu.

### Controls and Actions:

- Edit** Edit the project details. See [Edit Project](#).
- Export** In Android devices this will open an email client with the body of the email pre-filled with the data for the selected project. You can then email (or copy the message body to transfer in an alternative way) to the target device where the data can be pasted into the [Import Project](#) page. There are more options with an Apple device as you can save to local or cloud storage.
- Delete** This will delete the project from the app.

---

## Main Menu

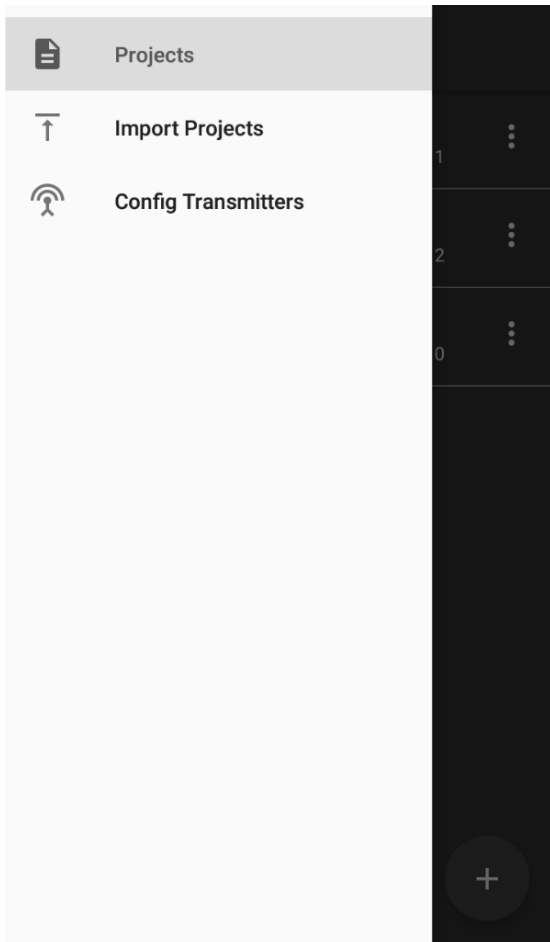

Android

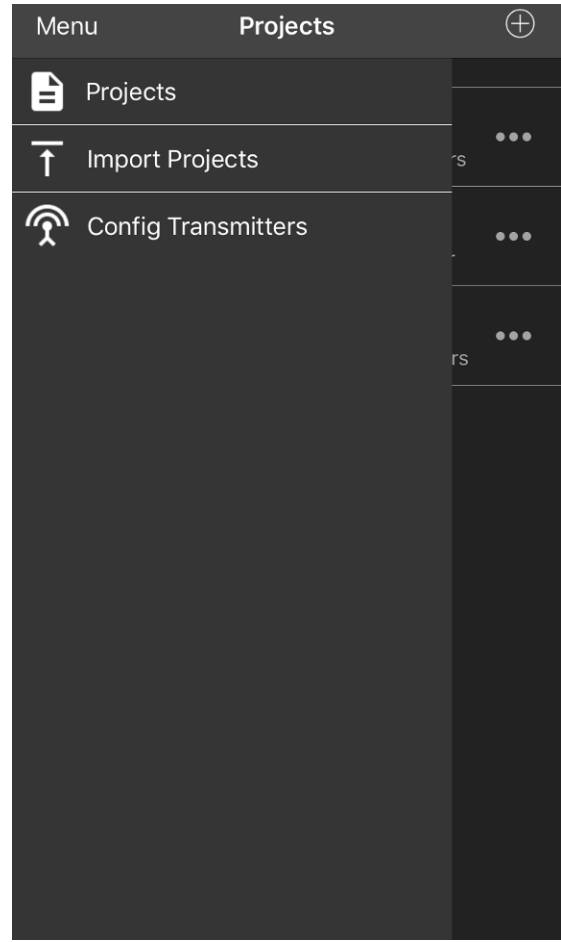

iOS

### Controls and Actions:

|                     |   |
|---------------------|---|
| Projects            | Takes you back to the <a href="#">Project List</a> .  |
| Import Projects     | Allows you to paste information exported from another app to import the project into this app. See <a href="#">Import Projects</a>  |
| Config Transmitters | This opens the <a href="#">Find Transmitters</a> page and will list all detected transmitters. Use the menu to the right of the required transmitter and select Configure to select that transmitter for configuration. See <a href="#">Configure Transmitter</a> page. |

---

## Import Project

Paste the data and tap the Import button. You will be taken back to the [Project List](#) and the new imported project will appear in the list.

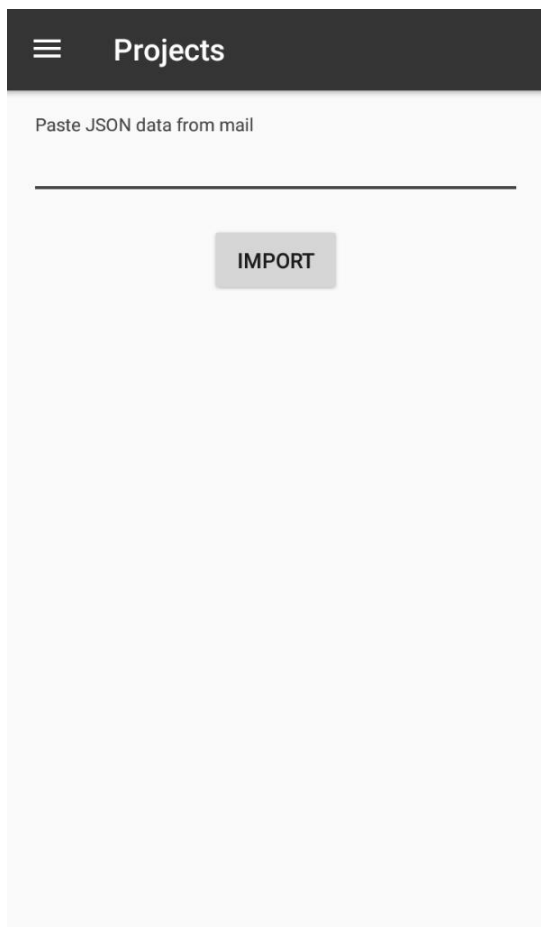

Android

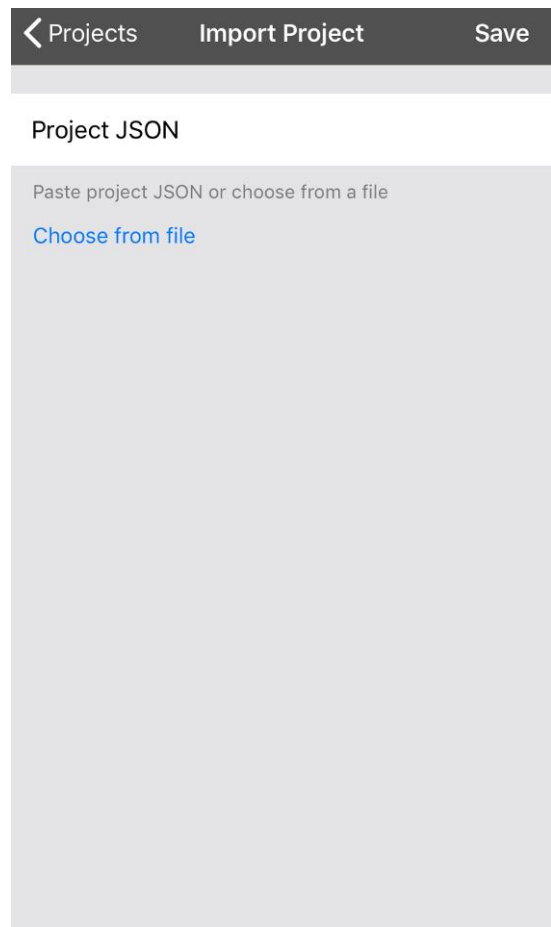

iOS

In Android paste the data and click the Import button.

In iOS you can either paste the data or click **Choose from file** to navigate to cloud or on-phone storage to select a file created by a previous export.

Also see [Project List Edit](#) for exporting projects.

## New Project

The screenshot shows the 'New Project' form on an Android device. The header bar is dark with a back arrow, the text 'New Project', and a checkmark. The form fields are as follows:

- Project Name:** A text input field with a character count of '0 / 30'.
- Icon:** A section with the text 'No icon selected' and a circular button containing a plus sign.
- View PIN:** A text input field containing the PIN '0000'.
- IF TRANSMITTERS ARE USING A PIN:** A greyed-out section.
- Timeout:** A dropdown menu currently set to '12 seconds'.
- Transmitters:** A section with the text 'Linked transmitters: 0'.

Android

The screenshot shows the 'New Project' form on an iOS device. The header bar is dark with a back arrow, the text 'New Project', and a 'Save' button. The form fields are as follows:

- Project Name:** A text input field with a character count of '0 / 30'.
- Icon:** A section with a plus sign icon in a circle.
- View Pin:** A text input field containing the PIN '0000'.
- IF TRANSMITTERS ARE USING A PIN:** A greyed-out section.
- Timeout:** A text input field containing '1 second'.
- Linked Transmitters:** A text input field containing '0'.

iOS

The settings and actions on this page are identical to those on the [Edit Project](#) page.

# Edit Project

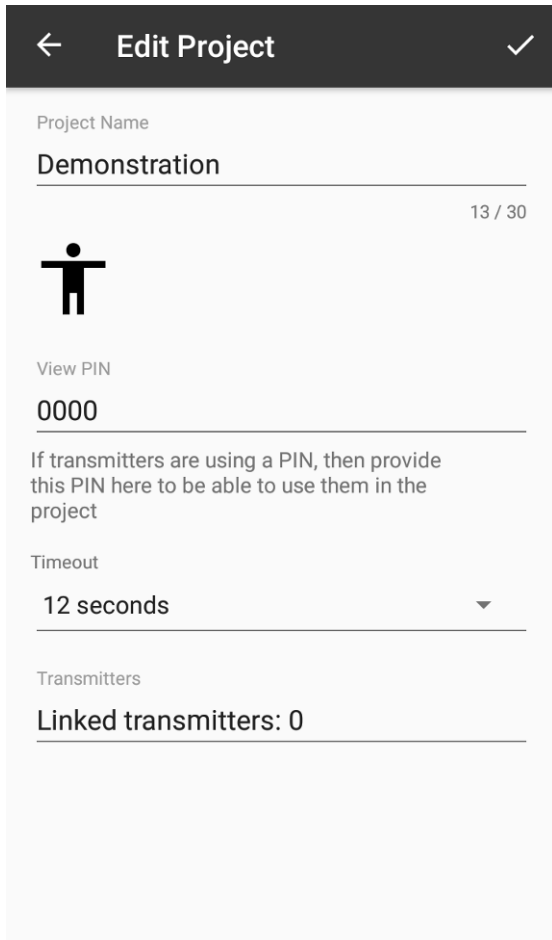

Android

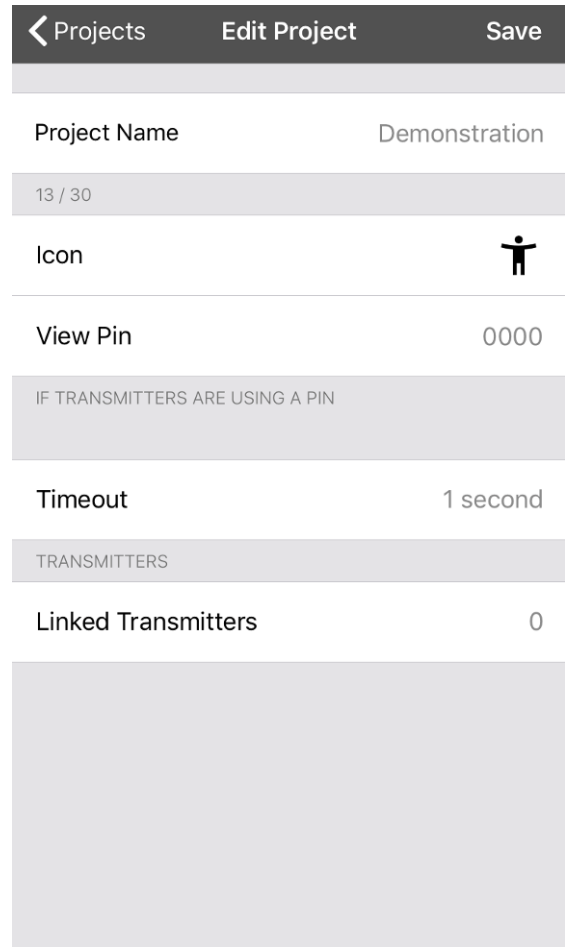

iOS

This page is where you define and edit the characteristics of the project (Not the dashboard).

## Controls and Actions:

y / <Projects

This will take you back to the [Project List](#) page. You can use this to cancel any changes made. You will be asked if you want to save or discard any changes.

p / Save

OK – Finish editing so go back to Project List page. See [Project Edit List](#) page

### Project Name

Set the project title/description.



Icon – Tap the existing icon to select a new icon from the icon list. (If no icon is set for this project tap the **V** to add one.

### View PIN

The View PIN you set in the project must match the View PIN configured in each of the transmitters you add to the project. Without the correct PIN you cannot see the data from the transmitters. The View PIN defaults to **0000**.

### Timeout

Select from the list the number of seconds that can elapse without receiving data from a transmitter before it is flagged as Out of Range. See [Error Bar](#).



 *This should be at least 3 X the transmit interval of the transmitters.*

### **Linked Transmitters**

This shows the total number of transmitters linked to this project. Tap to configure the linked transmitters.

See [Linked Transmitters](#).

## Linked Transmitters

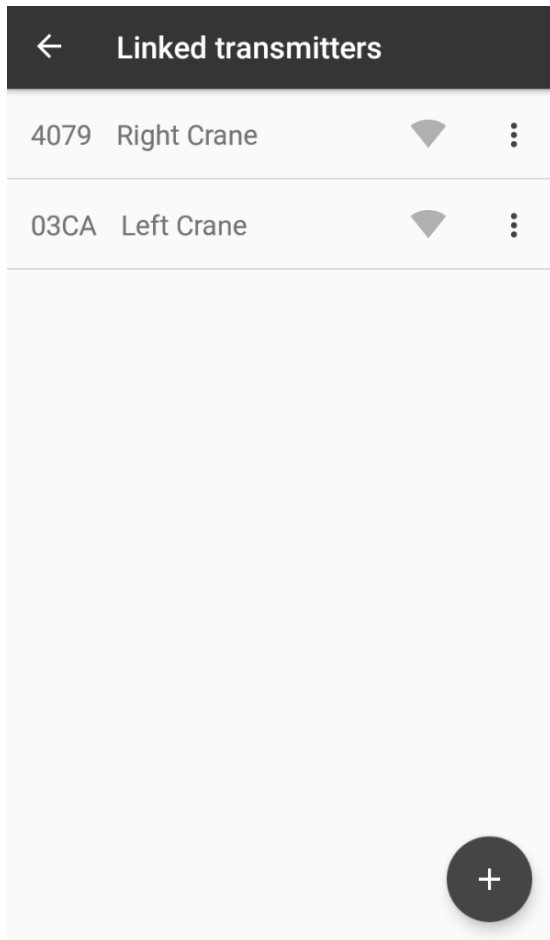

Android

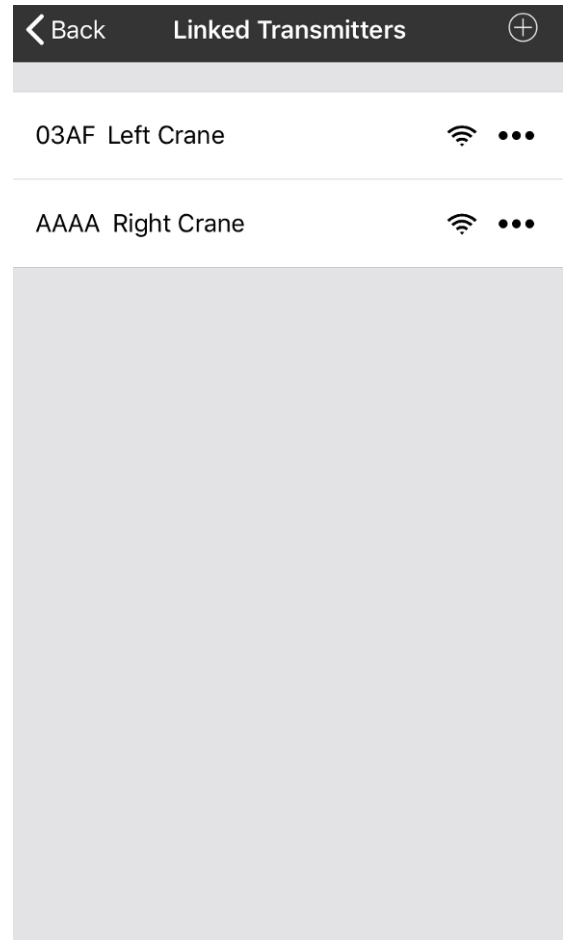

iOS

This page shows the list of transmitters linked to this project and will be available to be referenced in tile expressions for this project. Linking transmitters does not stop them being used by different projects even at the same time on different phones or tablets.

### Controls and Actions:

**y / <Back** This will take you back to the [Edit Project](#) page.

**u / J** Transmitter menu – The menu allows you to edit, configure or delete this transmitter.

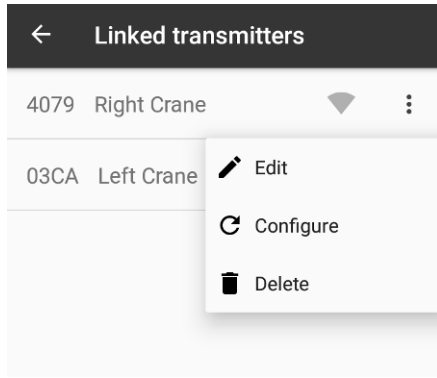

Android

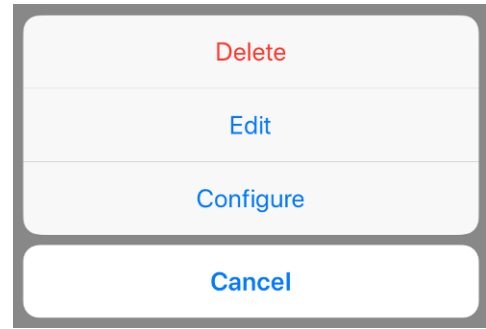

iOS

See [Edit Transmitter](#). See [Configure Transmitter](#).

You will not be able to delete a transmitter if it is referenced in the expression of any tiles on the dashboard.

V / I

Add a new transmitter to the list. This opens the [Add Transmitter](#) page.

## Add Transmitter

Android

iOS

Add a new transmitter to the project either by manually entering the Data Tag and description or searching for transmitters. By adding a transmitter it becomes available to be referenced in the expressions for tiles on the dashboard.

### Controls and Actions:

y \ <Back

This will take you back to the [Linked Transmitters](#) page. You can use this to cancel any changes made. You will be asked if you want to save or discard any changes.

w

Find Transmitters – This displays a list of currently detected transmitters allowing you to select or configure one. See [Find Transmitters](#) page.

p \ Save

Accept the currently entered data and return to the Linked Transmitters page.

Data Tag

The Data Tag of the transmitter.

Description

Your description for this transmitter. This name will be used in the expression builder.

## Find Transmitters

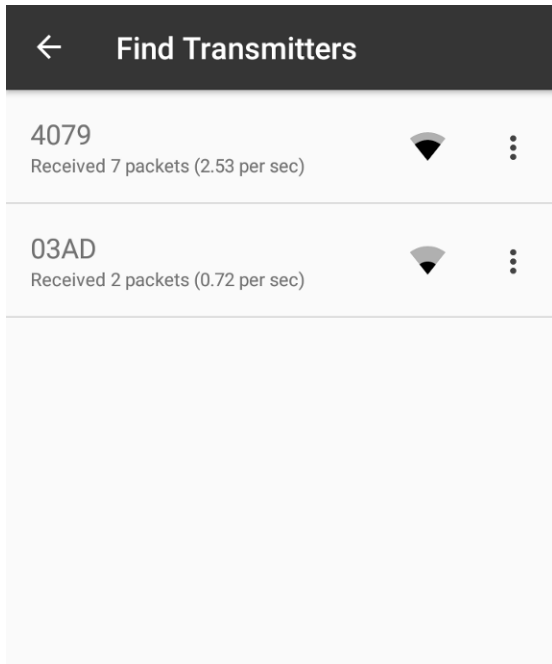

Android

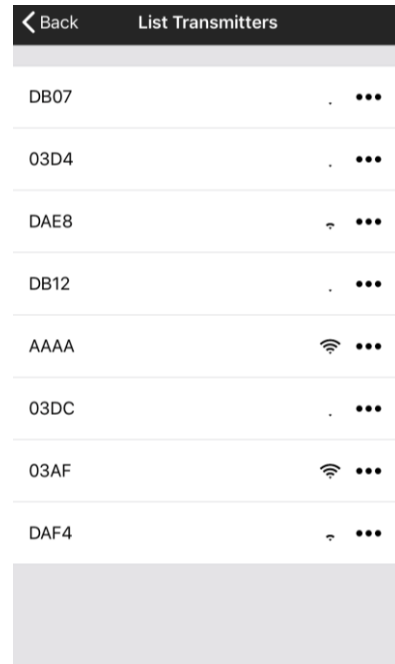

iOS

This page is displayed after selecting Configure Transmitter from the [Main Menu](#) or selecting search when adding a transmitter to a project. This lists all detected transmitters regardless of any PIN settings. If you are searching for transmitters to add to a project simply tap on the transmitter item to select it.

### Controls and Actions:

y \ <Back

Back to the [Main Menu](#) or [Add Transmitter](#) page.

u / J

Transmitter menu – The menu allows you to configure the selected transmitter.

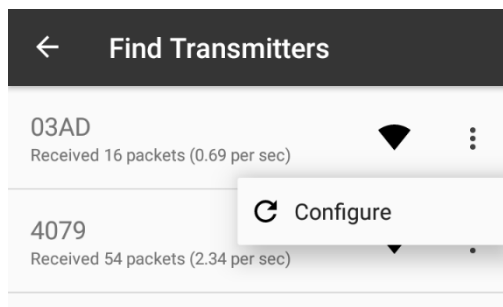

Android

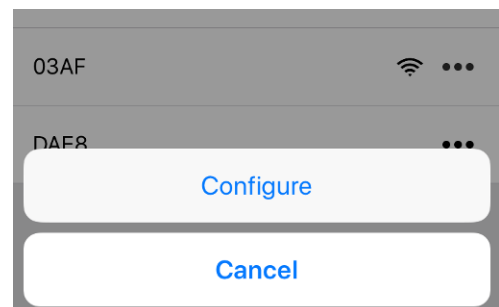

iOS

See [Configure Transmitter](#).

For each transmitter there is a display of the count of the number of packets received and the rate at which they are received.

An indicator showing the strength of the received signal is also displayed.

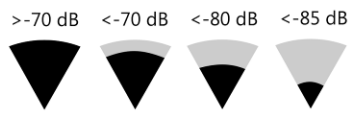

Android

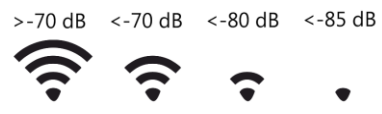

iOS

---

## Edit Transmitter

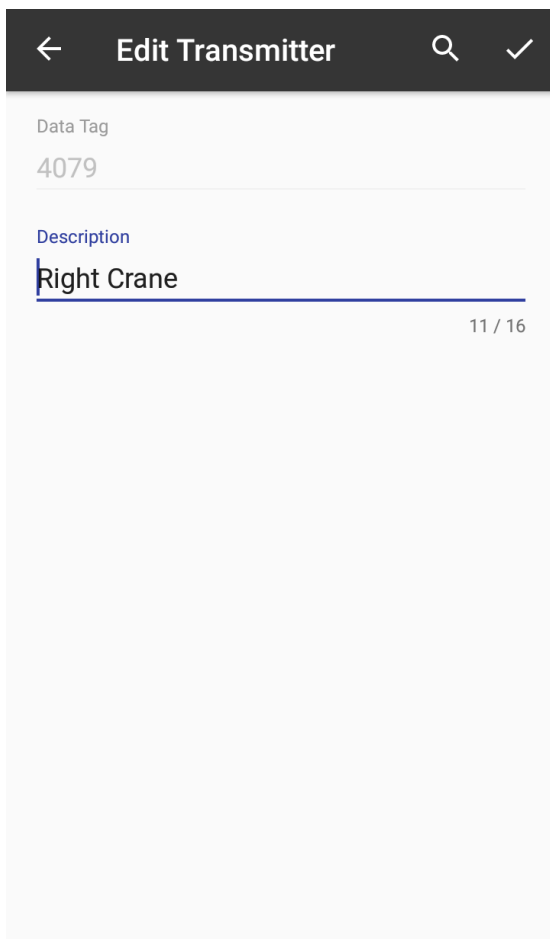

Android

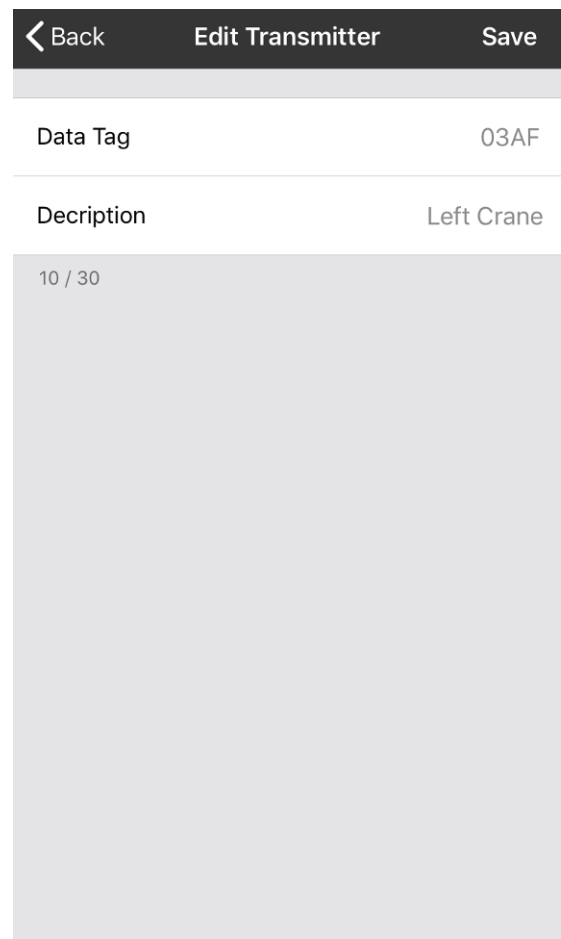

iOS

This page is where you can edit the description of a linked transmitter. Note that you cannot change the Data Tag.

### Controls and Actions:

y \ <Back

Back to [Linked Transmitters](#) page.

p \ Save

OK – Finish editing so go back to the Linked Transmitters page.

**Data Tag**

This is displayed but cannot be changed.

**Description**

Allows you to the description for this transmitter. The description is used to recognise the transmitter when referencing it in the tile expressions. This description is only relevant to this particular project.

## Project Dashboard Blank

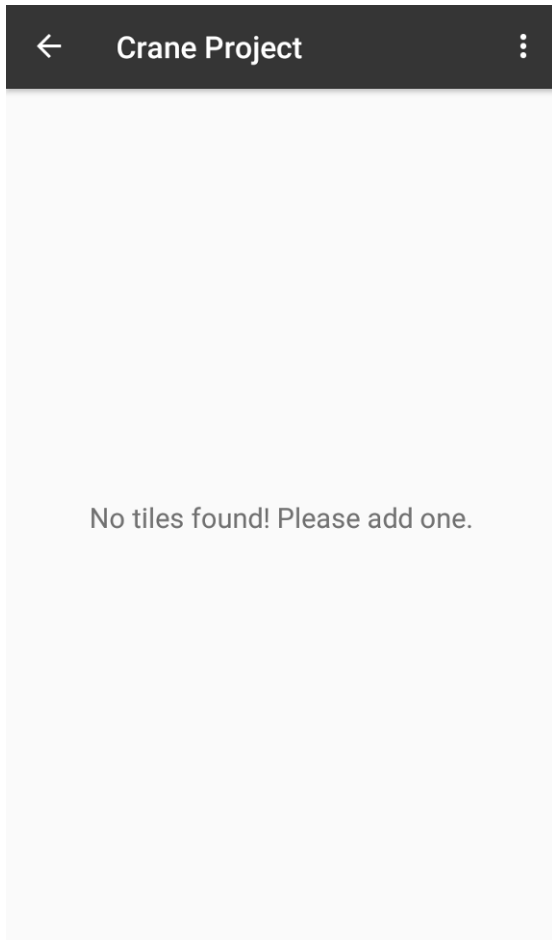

Android

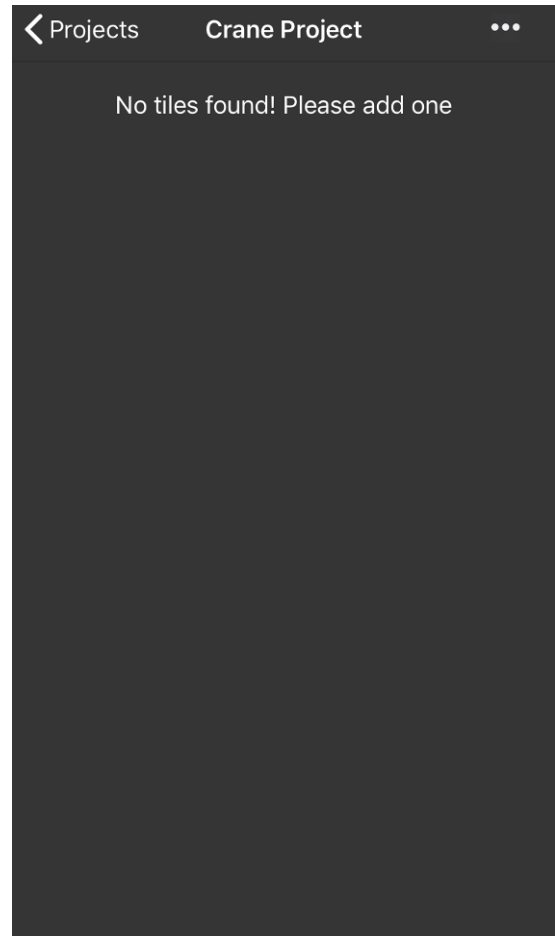

iOS

After creating a new project then selecting it from the Project List you will be presented with an empty Dashboard.

### Controls and Actions:

y \ <Projects

This will take you back to the [Project List](#) page.

u / J

Opens the dashboard menu where you can add a new tile.

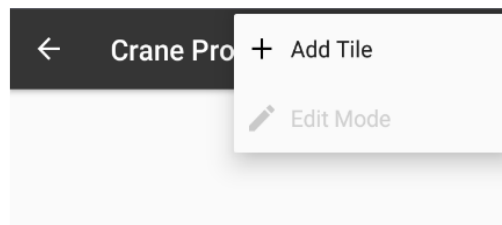

Android

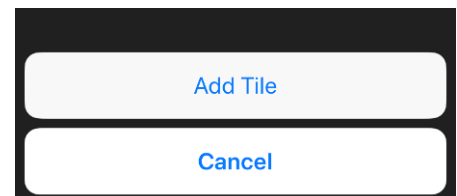

iOS

See the [Add Tile](#) page.



## Dashboard Add Tile

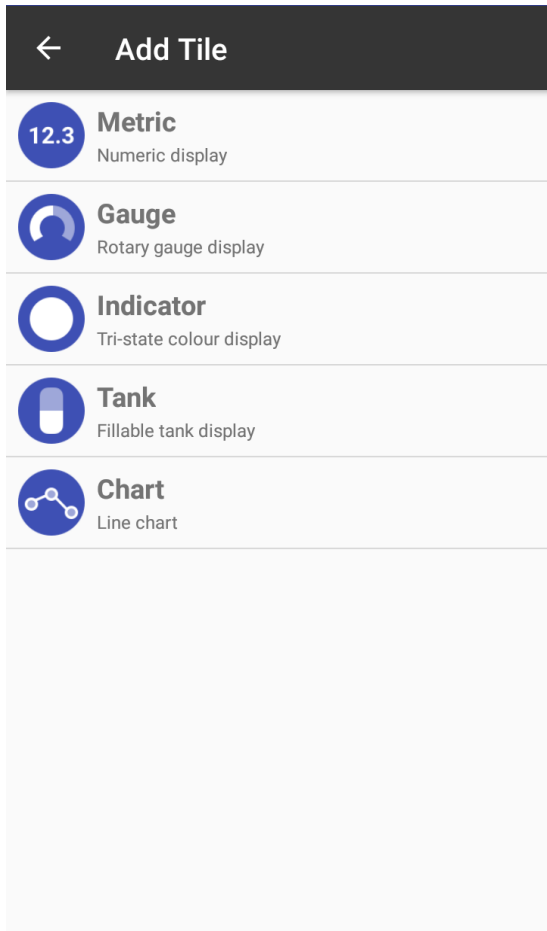

Android

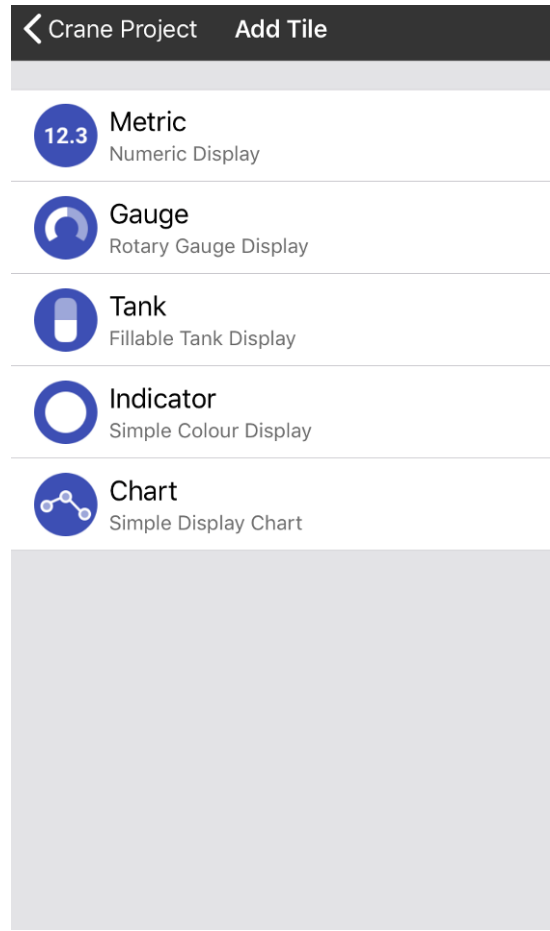

iOS

After tapping on Add Tile in a Dashboard menu you are presented with this page to allow selection of the required Tile.

### Controls and Actions:

y \ <Project

Go back to the dashboard. See [Dashboard Example](#) page

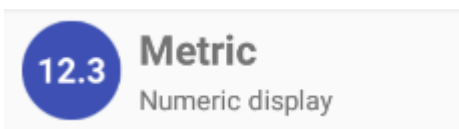

[Metric Tile](#) – Displays a numeric value and can optionally capture peak and valley values. A long press on the tile can optionally reset peak or valley or tare the tile value or tare the transmitter value of all transmitters used by this tile which will affect all tiles referencing the same transmitters in the project

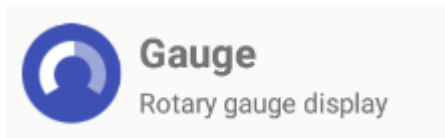
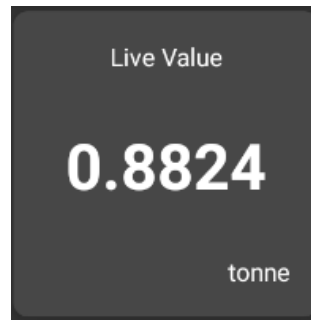

[Gauge Tile](#) – Shows a graphical gauge representation of a numeric value. You can specify the minimum and maximum values of the range and also define two value points giving the ability to display three different gauge colours depending on the value.

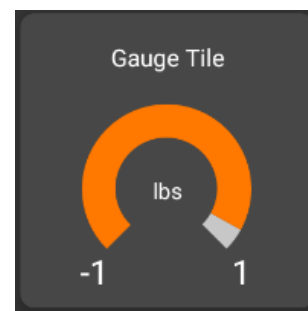

[Indicator Tile](#) - A simple coloured indicator that can display up to three colours depending on the value.

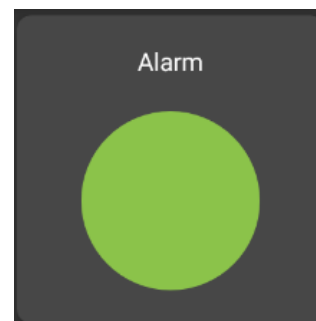

[Tank Tile](#) – This tile graphically represents a filling tank. You can specify the minimum and maximum values and two value points giving the ability to display three different tank fill colours depending on the value.



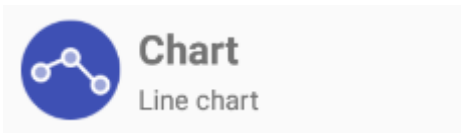

[Chart Tile](#) – This tile displays a definable number of historic values in a scrolling chart. You can specify the minimum and maximum values for the Y axis or let the chart auto scale. The trace colour can also be defined.

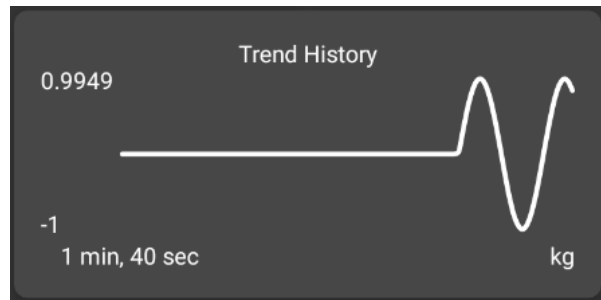

Tap the required tile to open the properties page. After configuring the Tile you will be returned to the dashboard.

## Project Dashboard Populated Example

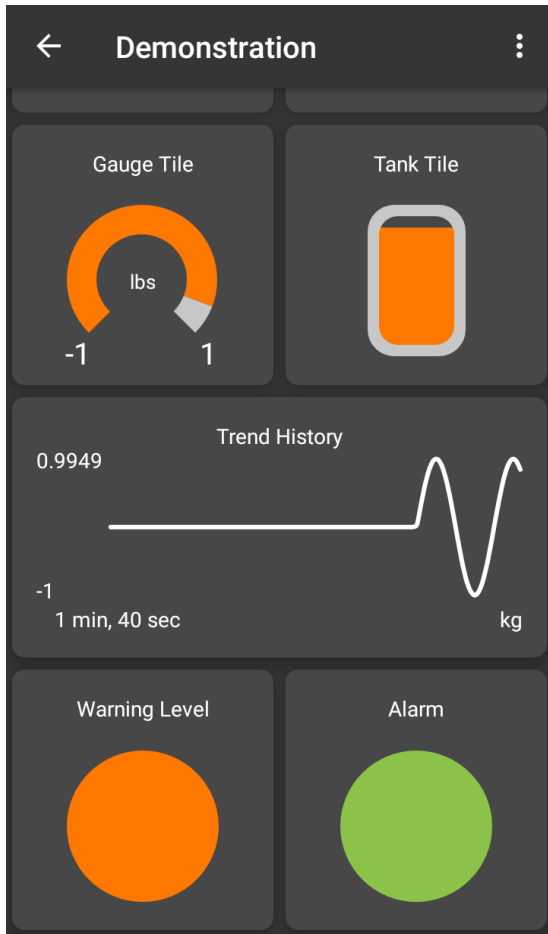

Android

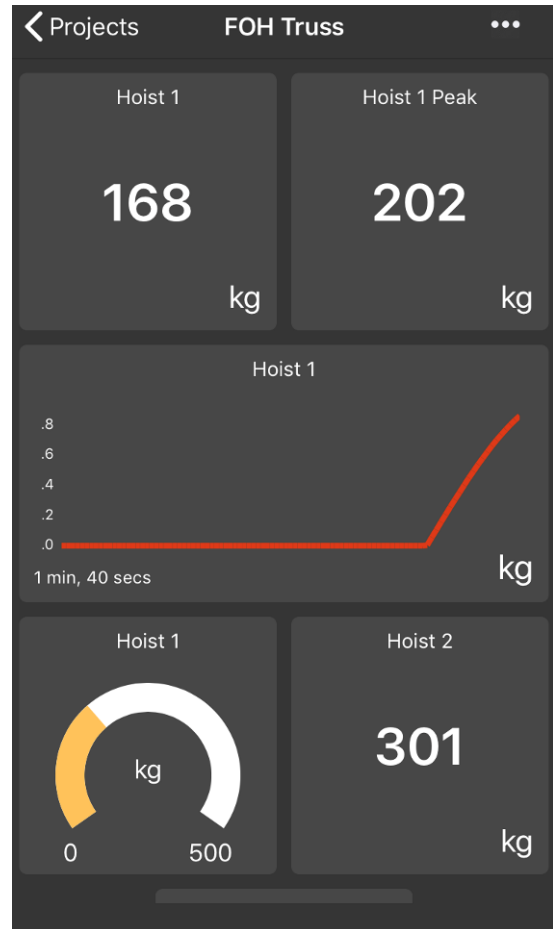

iOS

This page shows an example of a populated dashboard. The tiles will be displaying the real-time data from their evaluated expressions and will include the live data from the linked transmitters. If errors are detected in any of the transmitters an error bar will appear at the bottom of the screen. See [Error Bar](#)

### Controls and Actions:

y / <

This will take you back to the [Project List](#) page.

u / J

Opens the dashboard menu where you can add a new tile or enter edit mode.

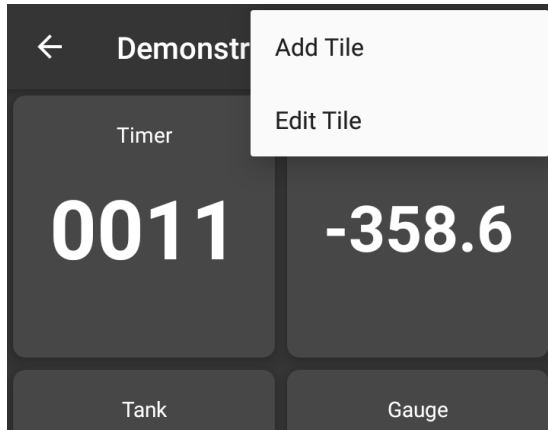

Android

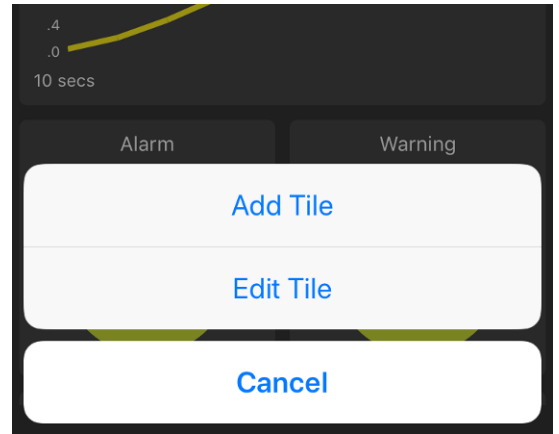

iOS

See the [Add Tile](#) page. See [Edit Mode](#) page.

## Project Dashboard Edit Mode



Android



iOS

When in edit mode each Tile on the Dashboard displays edit controls.

### Controls and Actions:

y \ <Projects

This will take you back to the [Project List](#) page.

u \ Save

Android - Opens the dashboard menu where you choose to go back to View Mode.  
iOS – saves the changes and goes back to View Mode.

k

This will open the edit page for the tile.  
See [Metric Tile](#), [Indicator Tile](#), [Gauge Tile](#), [Tank Tile](#), [Chart Tile](#).

n

This will allow you to delete the tile.

To re-arrange the tiles, simply press and hold on a tile for a second or two then drag it over, and drop it onto, the tile you would like to change positions with. In iOS you can see the tiles change places as you drag them around.

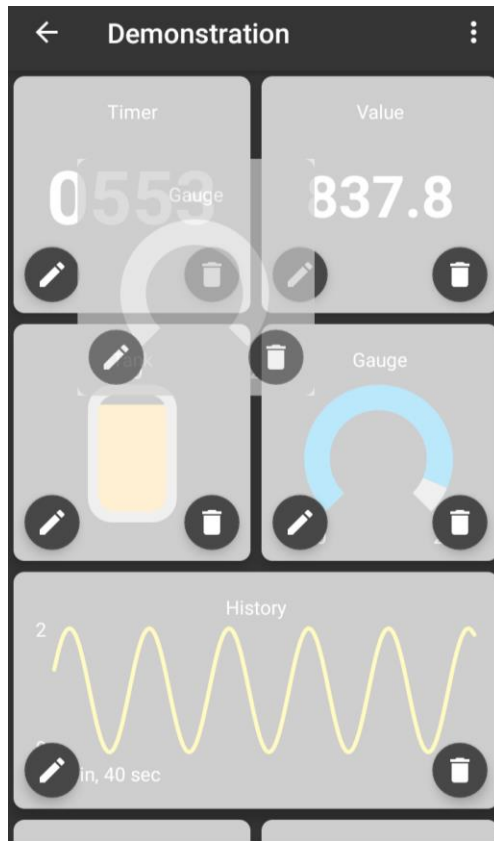

## Metric Tile

Android

iOS

This page is where you define the characteristics of the Metric Tile after either adding the tile or choosing to edit the tile.

The Metric Tile displays a numeric value that can optionally show maximum or minimum values. The tile can also optionally reset minimum or maximum or tare (zero) when pressed.

### Controls and Actions:

- y <Back** Cancel the edit and go back to the previous page. You will be offered the chance to save unsaved changes.
- p \ Save** OK – Finish editing and go back to the dashboard page.
- Name** Set the title to appear at the top of the tile. Each tile must have a name.
- Expression** This is where you define the value that is displayed in the tile. You can include references to any of the transmitters defined in the Linked Transmitters list along with various math functions. Tap in this area to open the [Expression Editor](#). Note that although you can see the text representation of the expression it must be edited in the Expression Editor.



|                       |   |
|-----------------------|---|
| <b>Source Units</b>   | This will display the engineering units that have been determined from the transmitters referenced by the expression. As long as there is just a single transmitter, or all transmitters share the same unit type, then this will show the engineering unit here. If the engineering units cannot be determined by the expression you entered, or you just want to override it, you can enter your own text instead.  |
| <b>Working Units</b>  | When the Units (Entered above) are recognised then on tapping this section you will be presented with a list of engineering units that the displayed value can be automatically converted to. See <a href="#">Unit Conversions</a> .<br>If the Units are not recognised you get the option of choosing your custom text to display.<br>In all cases you can choose to display no units by selecting None.   |
| <b>Output</b>         | Select either Actual Value, Maximum Value or Minimum Value. The maximum and minimum are only recorded during the lifespan of the displayed dashboard and can be reset by a long press on the tile if the correct action has been selected below.  |
| <b>Numeric Format</b> | Select the format for the displayed data. There are options available for different combinations of integer and decimal digits. Note that if the integer numeric value will not fit into the requested format then the value <i>will</i> be displayed.  |
| <b>Action</b>         | Select the action to execute when you tap and long hold the tile.<br><b>None</b> – No action occurs.<br><b>Individual Sources</b> – This effectively zeroes the values of all transmitters referenced in the expression in this tile. If the transmitters are used in the expressions of any other tiles then those will be affected as well. (This does not zero the actual value transmitted by the module)<br><b>Tile Only</b> – Zero the current tile display only.<br><b>Reset Min/Max</b> – If the tile action is to capture minimum or maximum then this option will reset the captured value back to the current value. |

## Indicator Tile

Android

iOS

This page is where you define the characteristics of the Indicator Tile after either adding the tile or choosing to edit the tile.

The Indicator Tile shows a coloured circle whose colour depends on the value of the expression. This can be used for fast go/no go verification of value range. i.e. are all my sensors below 100kg? Or to show blue below 10kg, green between 10kg and 50kg then red above 50kg.

### Controls and Actions:

- y <Back** Cancel the edit and go back to the previous page. You will be offered the chance to save unsaved changes.
- p \ Save** OK – Finish editing and go back to the dashboard page.
- Name** Set the title to appear at the top of the tile. Each tile must have a name.
- Expression** This is where you define the value that is displayed in the tile. You can include references to any of the transmitters defined in the Linked Transmitters list along with various math functions. Tap in this area to open the [Expression Editor](#). Note

that although you can see the text representation of the expression it must be edited in the Expression Editor.

### **Source Units**

This will display the engineering units that have been determined from the transmitters referenced by the expression. As long as there is just a single transmitter, or all transmitters share the same unit type, then this will show the engineering unit here. If the engineering units cannot be determined by the expression you entered, or you just want to override it, you can enter your own text instead.

### **Working Units**

When the Units (Entered above) are recognised then on tapping this section you will be presented with a list of engineering units that the displayed value can be automatically converted to. See [Unit Conversions](#). The selected working units will be used when the tile refers to your entered colour change thresholds.

If the Units are not recognised you get the option of choosing your custom text to display.

In all cases you can choose to display no units by selecting None.

### **Colours and thresholds**

Enter two threshold values which will determine the colour of the indicator. When the value is less than the first threshold the first colour will be used. When the value is greater or equal to the first threshold and less than the second threshold the middle colour will be used. When the expression value is greater or equal to the second threshold the third colour will be used.

## Gauge Tile

Android

iOS

This page is where you define the characteristics of the Gauge Tile after either adding the tile or choosing to edit the tile.

The Gauge Tile shows a gauge mimic where the expression value is indicated over a range defined by the user. The filled part of the gauge can also change colour depending on the expression value.

### Controls and Actions:

- |                   |  |
|-------------------|--|
| <b>y &lt;Back</b> | Cancel the edit and go back to the previous page. You will be offered the chance to save unsaved changes.  |
| <b>p \ Save</b>   | OK – Finish editing and go back to the dashboard page.   |
| <b>Name</b>       | Set the title to appear at the top of the tile. Each tile must have a name.  |
| <b>Expression</b> | This is where you define the value that is displayed in the tile. You can include references to any of the transmitters defined in the Linked Transmitters list along with various math functions. Tap in this area to open the <a href="#">Expression Editor</a> . Note that although you can see the text representation of the expression it must be edited in the Expression Editor. |

|                               |  |
|-------------------------------|--|
| <b>Source Units</b>           | This will display the engineering units that have been determined from the transmitters referenced by the expression. As long as there is just a single transmitter, or all transmitters share the same unit type, then this will show the engineering unit here. If the engineering units cannot be determined by the expression you entered, or you just want to override it, you can enter your own text instead.   |
| <b>Working Units</b>          | <p>When the Units (Entered above) are recognised then on tapping this section you will be presented with a list of engineering units that the displayed value can be automatically converted to. See <a href="#">Unit Conversions</a>. The selected working units will be used when the tile refers to your entered colour change thresholds and min/max values.</p> <p>If the Units are not recognised you get the option of choosing your custom text to display.<br/>In all cases you can choose to display no units by selecting None.</p> |
| <b>Min</b>                    | The expression value at which, or below, the gauge will show a minimum level.  |
| <b>Max</b>                    | The expression value at which, or above, the gauge will show a maximum level.  |
| <b>Colours and thresholds</b> | Enter two threshold values which will determine the colour of the indicator. When the value is less than the first threshold the first colour will be used. When the value is greater or equal to the first threshold and less than the second threshold the middle colour will be used. When the expression value is greater or equal to the second threshold the third colour will be used.  |

# Tank Tile

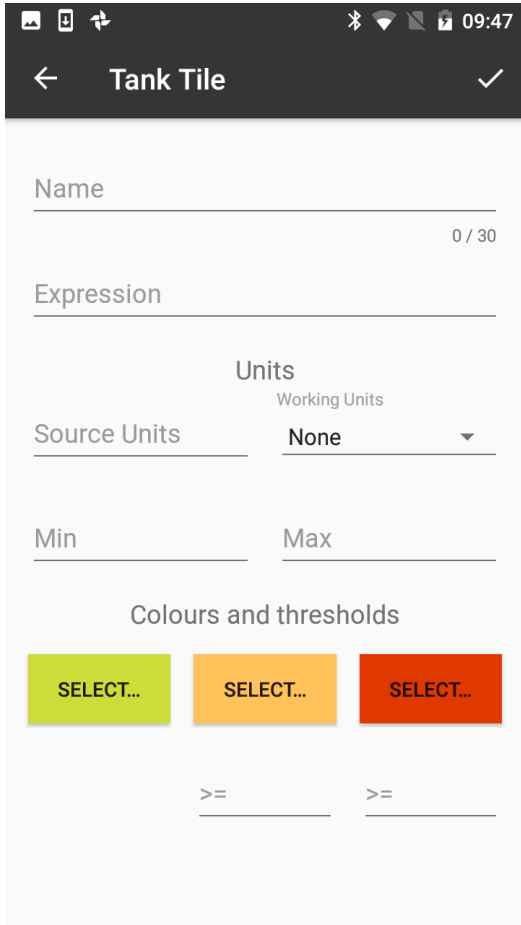

Android

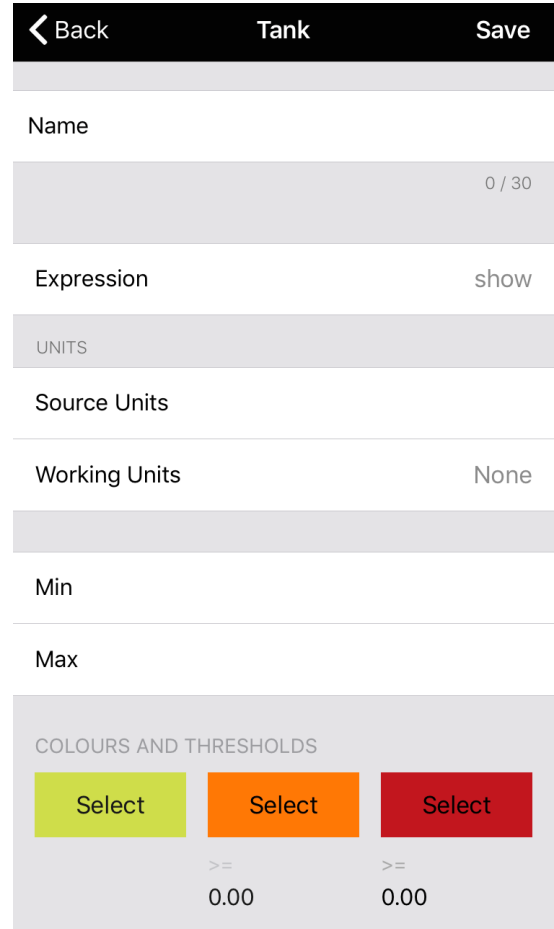

iOS

This page is where you define the characteristics of the Tank Tile after either adding the tile or choosing to edit the tile.

The Tank Tile shows a tank mimic where the expression value is indicated as a fill level over a range defined by the user. The filled part of the tank can also change colour depending on the expression value.

### Controls and Actions:

- y <Back** Cancel the edit and go back to the previous page. You will be offered the chance to save unsaved changes.
- p \ Save** OK – Finish editing and go back to the dashboard page.
- Name** Set the title to appear at the top of the tile. Each tile must have a name.
- Expression** This is where you define the value that is displayed in the tile. You can include references to any of the transmitters defined in the Linked Transmitters list along with various math functions. Tap in this area to open the [Expression Editor](#). Note that although you can see the text representation of the expression it must be edited in the Expression Editor.

|                               |  |
|-------------------------------|--|
| <b>Source Units</b>           | This will display the engineering units that have been determined from the transmitters referenced by the expression. As long as there is just a single transmitter, or all transmitters share the same unit type, then this will show the engineering unit here. If the engineering units cannot be determined by the expression you entered, or you just want to override it, you can enter your own text instead.   |
| <b>Working Units</b>          | <p>When the Units (Entered above) are recognised then on tapping this section you will be presented with a list of engineering units that the displayed value can be automatically converted to. See <a href="#">Unit Conversions</a>. The selected working units will be used when the tile refers to your entered colour change thresholds and min/max values.</p> <p>If the Units are not recognised you get the option of choosing your custom text to display.<br/>In all cases you can choose to display no units by selecting None.</p> |
| <b>Min</b>                    | The expression value at which, or below, the tank will show a minimum level.   |
| <b>Max</b>                    | The expression value at which, or above, the tank will show a maximum level.   |
| <b>Colours and thresholds</b> | Enter two threshold values which will determine the colour of the indicator. When the value is less than the first threshold the first colour will be used. When the value is greater or equal to the first threshold and less than the second threshold the middle colour will be used. When the expression value is greater or equal to the second threshold the third colour will be used.  |

## Chart Tile

Android

iOS

This page is where you define the characteristics of the Gauge Tile after either adding the tile or choosing to edit the tile.

The Chart Tile shows a historical trend chart where the expression value is used to plot points. The history is only shown during the duration of the dashboard being displayed. Note that there are no units shown for the X axis. Unlike the other tiles, the user can specify the rate at which the chart is updated as well as the number of points to display.

A long press on the chart tile will allow the data held in the chart to be exported in the form of a CSV file. The options for exporting the file will be dependent on the device operating system and capabilities.

### Controls and Actions:

|                   |   |
|-------------------|---|
| <b>y &lt;Back</b> | Cancel the edit and go back to the previous page. You will be offered the chance to save unsaved changes.   |
| <b>p \ Save</b>   | OK – Finish editing and go back to the dashboard page.  |
| <b>Name</b>       | Set the title to appear at the top of the tile. Each tile must have a name.   |
| <b>Expression</b> | This is where you define the value that is displayed in the tile. You can include references to any of the transmitters defined in the Linked Transmitters list along |



with various math functions. Tap in this area to open the [Expression Editor](#). Note that although you can see the text representation of the expression it must be edited in the Expression Editor.

**Source Units**

This will display the engineering units that have been determined from the transmitters referenced by the expression. As long as there is just a single transmitter, or all transmitters share the same unit type, then this will show the engineering unit here. If the engineering units cannot be determined by the expression you entered, or you just want to override it, you can enter your own text instead.

**Working Units**

When the Units (Entered above) are recognised then on tapping this section you will be presented with a list of engineering units that the displayed value can be automatically converted to. See [Unit Conversions](#). The selected working units will be used when the tile refers to your entered Y axis min and max values.

If the Units are not recognised you get the option of choosing your custom text to display.

In all cases you can choose to display no units by selecting None.

**Y Axis Min**

The minimum value to display on the Y axis.

**Y Axis Max**

The maximum value to display on the Y axis.

**History Points**

Select how many data points to display. Once the chart fills the old data will be scrolled off to the left. You can enter from between 10 and 10,000 points.

**Update Interval**

Select how often to add a new data point to the chart.

**Trace Colour**

Select a colour to use to plot the chart data.

# Expression Editor

The Expression Editor is used to define what value to display in the tile. You can build a mathematical expression that can contain references to the Transmitters that have been assigned to the Project. These references are converted to the actually transmitted value when the expression is evaluated.

Expressions can range from a simple single transmitter value through to complex math functions applied to multiple transmitter values.

The Expression Editor starts off with an empty cell.

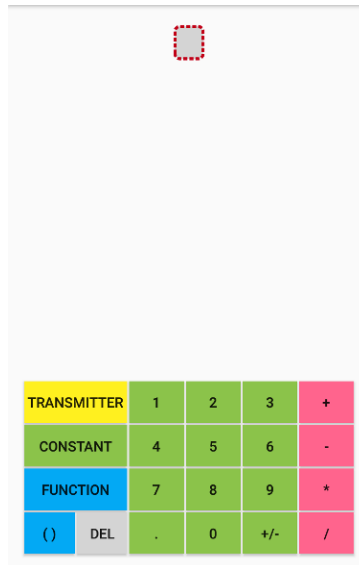

To add a reference to a Transmitter tap the Transmitter button and you will see a list of Transmitters that have been assigned to the Project.

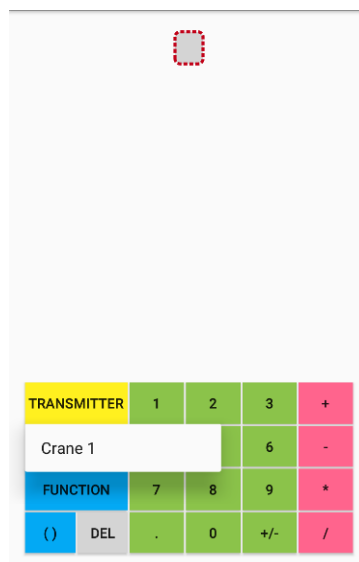

In this case there is just one transmitter named **Crane 1**. Just tap on the transmitter name to add it to the expression.

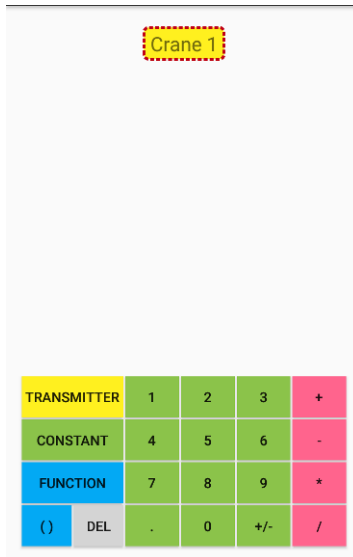

This would be enough to simply use the transmitter's value in the tile. If you wanted to view the Square Root of the transmitter value you can add a square root function. Select the required cell, in this case the **Crane 1**, and tap the **Function** button.

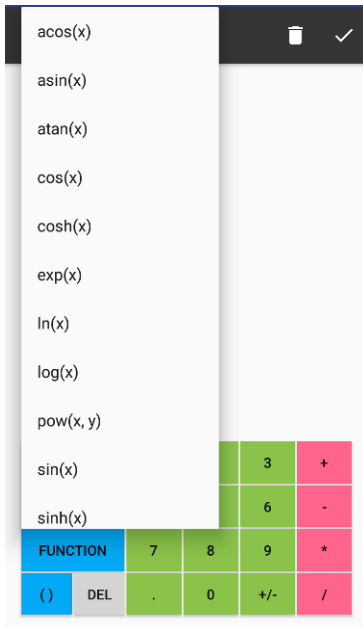

Android

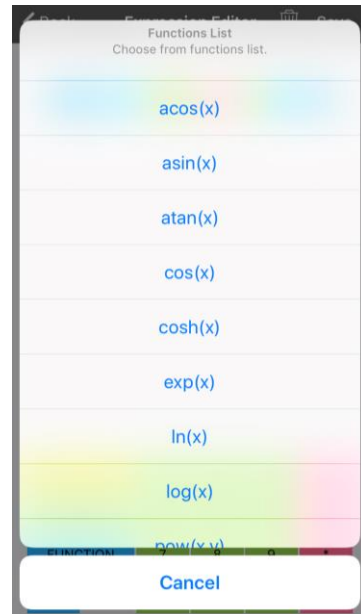

iOS

Scroll down to find the required function and tap to select.

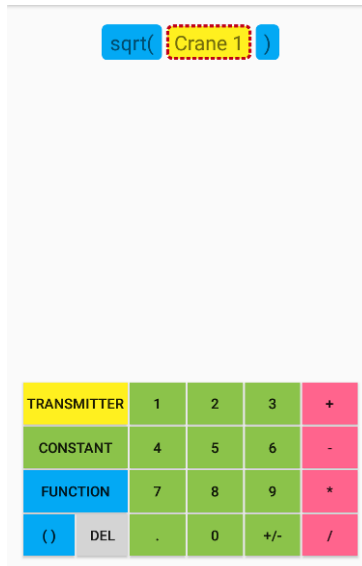

To add further items to the expression you need to select the appropriate cell before tapping more buttons. If we wanted to add some math to the **Crane 1** value *inside* the square root function you would highlight the **Crane 1** cell as shown above. Then when you tap the \* followed by the 2 button the expression will be built like this.

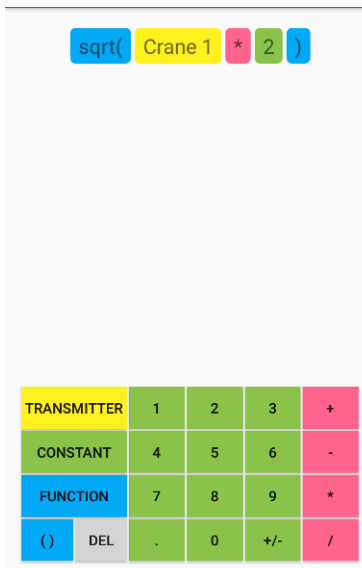

Had you wanted the \*2 to be applied after the square root function the **sqr(** cell should have been selected.

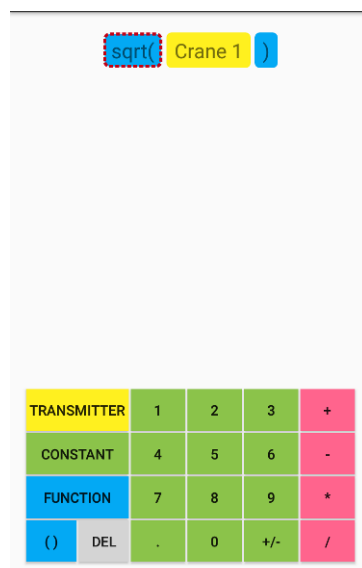

Then when you tap the \* followed by the 2 button the expression will be built like this.

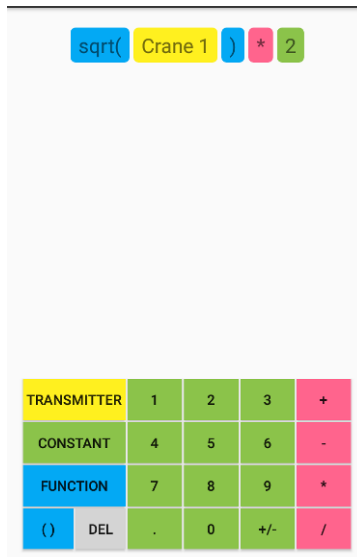

The image shows a calculator interface. At the top, the expression  $\sqrt{\text{Crane 1}} \times 2$  is displayed. Below the display is a keypad with the following layout:

|             |     |   |   |     |
|-------------|-----|---|---|-----|
| TRANSMITTER | 1   | 2 | 3 | +   |
| CONSTANT    | 4   | 5 | 6 | -   |
| FUNCTION    | 7   | 8 | 9 | *   |
| ( )         | DEL | . | 0 | +/- |
|             |     |   |   | /   |

If there is an existing function or set of brackets when you first open the Expression Editor and you want to add something after it, just highlight the function name or the leftmost bracket first.



Then when you type the characters will be added after the rightmost bracket.

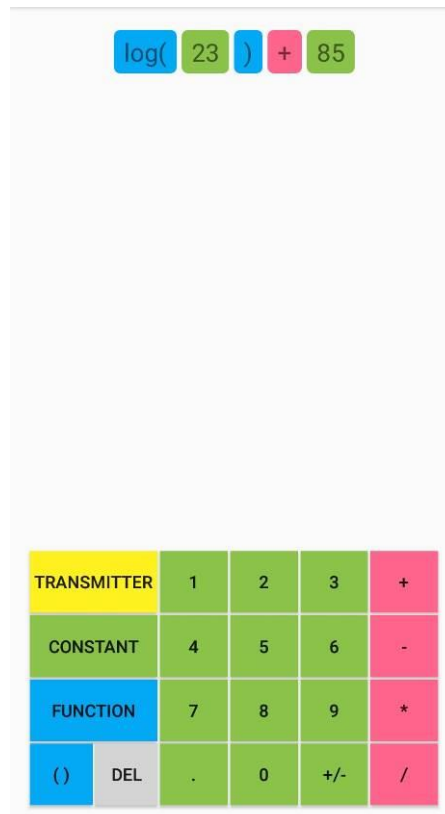

## Functions, Constants and Operators for Use in Expressions

Here is the complete list of available functions, operators and constants that can be used in expressions.

### Button

TRANSMITTER

### Functionality

Display a list of Transmitters allocated to the Project. Tap the desired transmitter name to add it to the expression.

CONSTANT

pi – PI, approximately equal to 3.14159  
e – base of the natural logarithm  
time – a simple second counter zeroed from when the dashboard is displayed. This can be used to create a timer tile or as a source for demonstration tiles.

FUNCTION

acos(x) - ArcCosine  
asin(x) - ArcSine  
atan(x) - ArcTangent  
cos(x) - Cosine  
cosh(x) - Hyperbolic Cosine  
exp(x) - Exponential  
ln(x) – Natural Logarithm  
log(x) – Logarithm (Base 10)  
pow(x,y) – Power  $x^y$   
sin(x) - Sine  
sinh(x) – Hyperbolic Sine  
sqrt(x) – Square Root  
tan(x) - Tangent  
tanh(x) – Hyperbolic Tangent

()

Place a set of brackets around the selected cell.

DEL

Delete the selected cell. Deleting a left bracket will delete everything enclosed within the bracket pair.

1

0

Enter the numeric digits 0-9 into the expression.

.

Add a decimal point to a numeric value.

+/-

Toggle the sign of the selected cell or value between negative and positive.

+

Addition operator.

-

Subtraction operator.

\*

Multiplication operator.

/

Division operator.

The icons along the top of the screen do the following:

y / < **Back**

Go back to the Tile Edit page. You will be asked if you want to discard any unsaved changes.

n

Clear everything in the expression editor.

p / **Save**

Save and finish editing the expression and return to the Tile Edit page.



---

## Unit Conversions

The app is able to convert between units automatically if the calibrated units of the transmitters are known. The following table shows the different categories that are recognized. If a unit is not in the list it is always possible to use the tile expressions to perform the desired unit calculations.

| Group              | Unit              | Symbol |
|--------------------|-------------------|--------|
| <b>Ratiometric</b> | mV/V              | mV/V   |
| <b>Angle</b>       | radians           | rad    |
|                    | degrees           | °      |
|                    | circumference     |        |
|                    | grade             |        |
|                    | minutes           | '      |
|                    | seconds           | "      |
|                    | revolutions       | rev    |
| <b>Length</b>      | meters            | m      |
|                    | angstrom          | Å      |
|                    | astronomical unit | AU     |
|                    | centimeters       | cm     |
|                    | chains gunters    | ch     |
|                    | ell               | ell    |
|                    | em                | em     |
|                    | fathoms           | fm     |
|                    | feet              | ft     |
|                    | furlongs          | fur    |
|                    | inches            | in     |
|                    | kilometers        | km     |
|                    | league            | lea    |
|                    | leagues           | league |
|                    | light years       | ly     |
|                    | lines             | ln     |
|                    | microns           | μ      |
|                    | miles nautical    | mi n   |
|                    | miles             | mi     |
|                    | millimeters       | mm     |
|                    | mils              | mil    |
|                    | nanometers        | nm     |
|                    | parsec            | pc     |
|                    | yards             | yd     |

|                   |                                     |                    |
|-------------------|-------------------------------------|--------------------|
| <b>Mass</b>       | kilograms                           | kg                 |
|                   | drams                               | dr av              |
|                   | grains                              | gr                 |
|                   | grams                               | g                  |
|                   | milligrams                          | mg                 |
|                   | ounces                              | oz                 |
|                   | pennyweights                        | pwt                |
|                   | pounds                              | lb                 |
|                   | kilopounds                          | klb                |
|                   | scruples                            | s ap               |
|                   | slug                                | slug               |
|                   | tons long                           | ton                |
|                   | tons metric                         | T                  |
|                   | tonnes                              | tonne              |
| tons short        | sh tn                               |                    |
| <b>Force</b>      | newtons                             | N                  |
|                   | kilonewtons                         | kN                 |
|                   | millinewtons                        | mN                 |
|                   | meganewtons                         | MN                 |
|                   | crinals                             | crinal             |
|                   | dynes                               | dyn                |
|                   | grams force                         | gf                 |
|                   | joules per cm                       | J/cm               |
|                   | kilograms force                     | kgf                |
|                   | kilograms force kp                  | kp                 |
|                   | kilograms meter/second <sup>2</sup> | kg ms <sup>2</sup> |
|                   | ounces force                        | ozf                |
|                   | pounds force                        | lbf                |
|                   | poundals                            | pdl                |
|                   | tons force long                     | tonfl              |
|                   | tons force short                    | tonfs              |
| tons force metric | tonfm                               |                    |
| <b>Pressure</b>   | bar                                 | bar                |
|                   | atmosphere techn                    | at                 |
|                   | atmosphere phys                     | atm                |
|                   | dyne/cm <sup>2</sup>                | dyncm <sup>2</sup> |
|                   | foot of water (39°F)                | ftH <sub>2</sub> O |
|                   | inch of water (39°F)                | inH <sub>2</sub> O |
|                   | gigapascal                          | GPa                |
|                   | hectopascal                         | hPa                |
|                   | kg force / cm <sup>2</sup>          | kgfcm <sup>2</sup> |

|                           |                    |
|---------------------------|--------------------|
| kg force / m <sup>2</sup> | kgf/m <sup>2</sup> |
| microbar                  | μbar               |
| pascal                    | Pa                 |
| newton/m <sup>2</sup>     | N/m <sup>2</sup>   |
| ounce(avdp)/square inch   | oz/in <sup>2</sup> |
| pounds per square foot    | lb/ft <sup>2</sup> |
| pounds per square inch    | psi                |
| tonne per square cm       | T/cm <sup>2</sup>  |

### Speed

|                    |        |
|--------------------|--------|
| meter/sec          | m/s    |
| centimeters/sec    | cm/s   |
| feet/min           | ft/min |
| feet/sec           | ft/s   |
| kilometers/hr      | km/h   |
| kilometers/min     | km/min |
| kilometers/sec     | km/s   |
| knots              | kn     |
| meters/hr          | m/h    |
| meters/min         | m/min  |
| miles/hr           | mph    |
| miles/min          | mpm    |
| miles/sec          | mps    |
| nautical miles/hr  | n mph  |
| nautical miles/min | n mpm  |
| nautical miles/sec | n mps  |

### Torque

|                |        |
|----------------|--------|
| newton meter   | N m    |
| meter kilogram | m kg   |
| foot pound     | ft lbf |
| foot poundal   | ft pdl |
| inch pound     | in lbf |

### Arbitrary

|        |        |
|--------|--------|
| counts | counts |
|--------|--------|

## Error Bar

The Error Bar appears at the bottom of the page in Dashboard View and informs you of problems with the transmitters.

Any errors (apart from Low Battery) will also cause all tiles containing the problematic transmitter to be rendered in a lighter colour.

If the warning is that the battery is low in one or more transmitters then the Error Box will be orange otherwise it will be red.

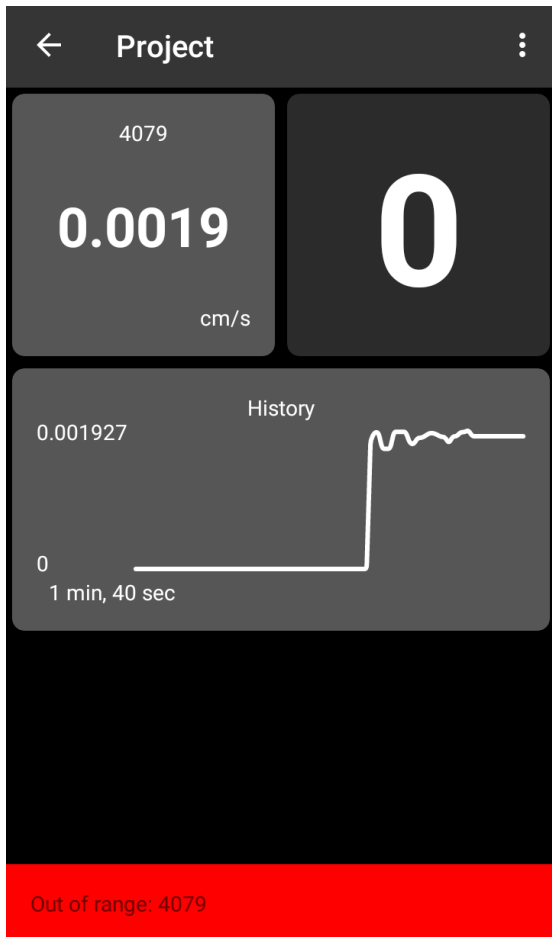

Android

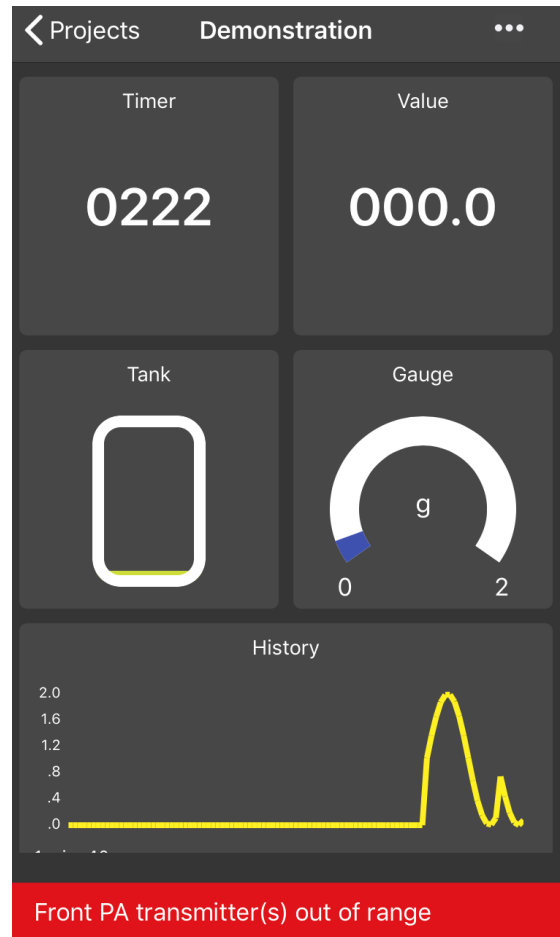

iOS

The following errors may be displayed followed by a list of the transmitters reporting the error identified by Data Tag.

- |                  |   |
|------------------|---|
| Battery Low      | The transmitter reports that its battery is low.  |
| Integrity Error  | The transmitter reports a detected problem with its connected sensor.   |
| Overrange Error  | The bridge input is too high.   |
| Out of Range     | The app has not received any data from the transmitter for longer than the timeout period.                                      |
| Shunt Cal Active | The module is in shunt calibration mode which will affect its transmitted value. (The app cannot force a module into this mode) |

## Icon List

Tap on an icon from the scrollable list to assign to the project.



Select the  icon to have no icon associated with the project.

## Configure Transmitter

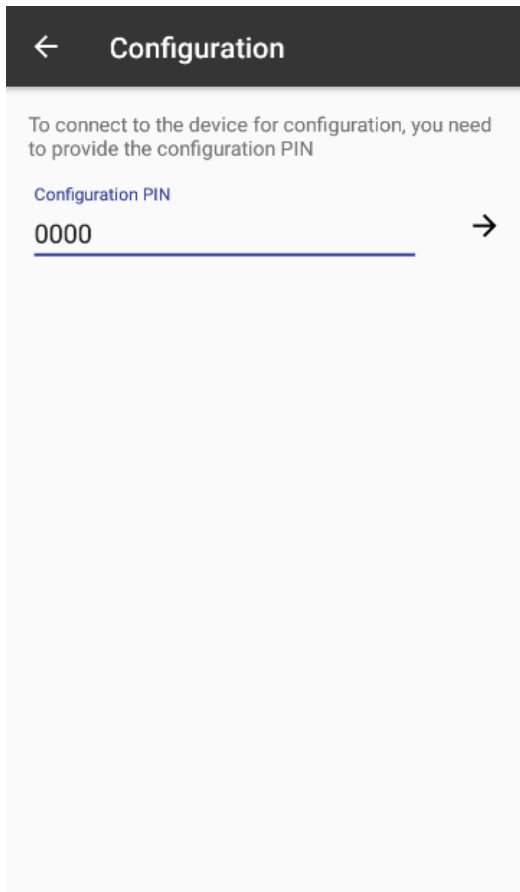

Android

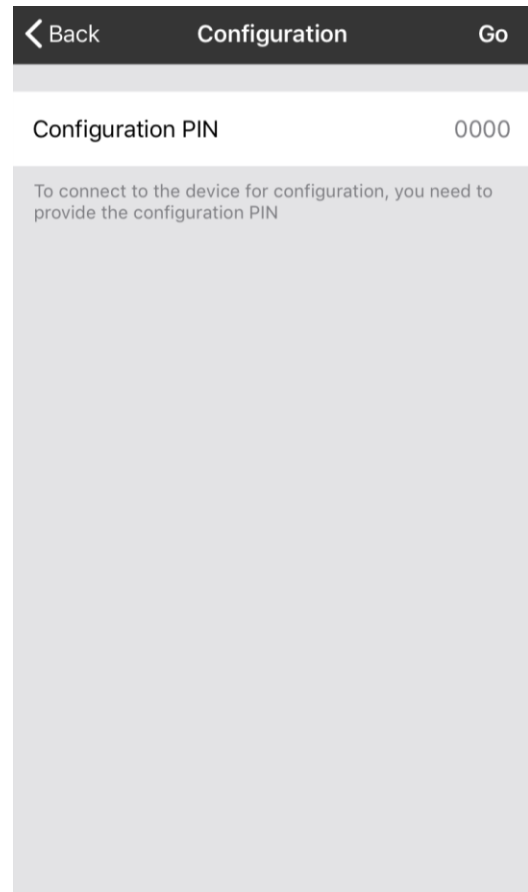

iOS

This page is where you connect to a transmitter to configure or calibrate it.

### Controls and Actions:

y / <Back Back to the [Find Transmitters](#) page.

**Configuration PIN** Enter the 4 digit configuration PIN that has been set in the transmitter. The connection will fail if the wrong configuration PIN is supplied.

z / Go Tap to attempt to connect to the transmitter. While the connection is being established messages will be displayed.

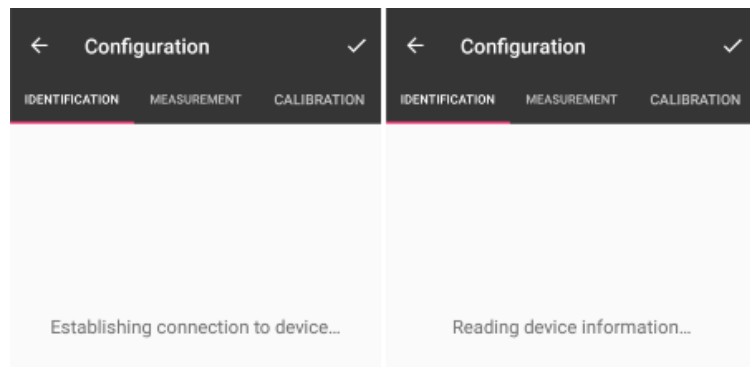

If the connection is successful then you will be able to see the three configuration tabs.

See [Configuration – Identification](#)

See [Configuration – Measurement](#)

See [Configuration – Calibration](#)

## Configuration Identification

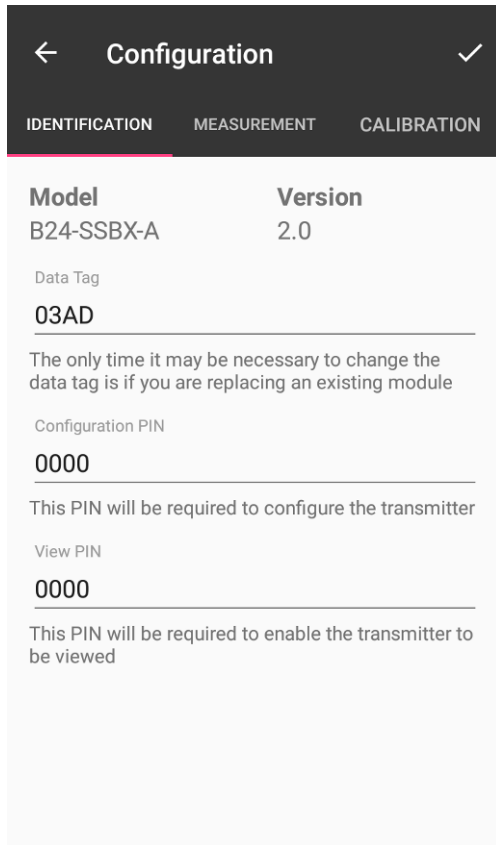

Android

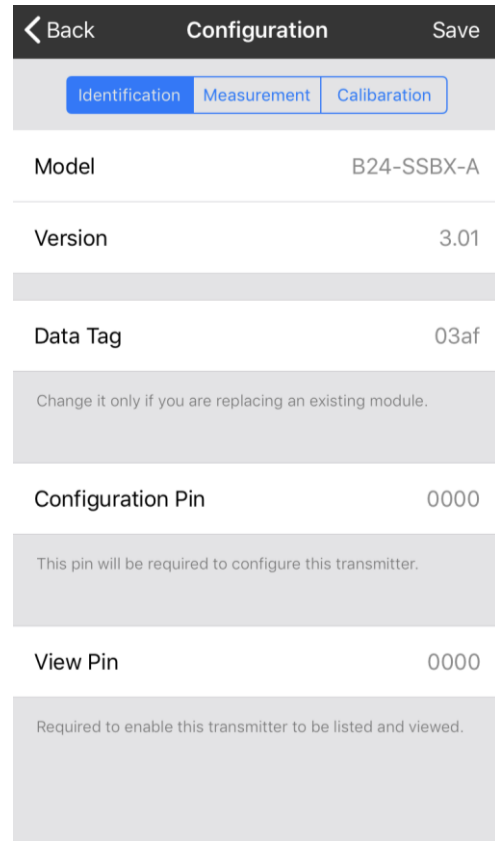

iOS

This page is shown after a successful connection to a Source and displays its main identification settings and allows some to be changed.

### Controls and Actions:

- |                          |   |
|--------------------------|---|
| y / <Back                | Cancel changes and go back to the previous page. Either <a href="#">Find Transmitters</a> or <a href="#">Linked Transmitters</a> page.  |
| p / Save                 | OK – Finish editing, save and go back to the previous page. Either <a href="#">Find Transmitters</a> or <a href="#">Linked Transmitters</a> page.                                 |
| <b>Model</b>             | Read only display of the transmitter module model number.   |
| <b>Version</b>           | Read only display of the transmitter module's firmware version.   |
| <b>Data Tag</b>          | This allows the Data Tag to be changed. The Data Tag is used to identify the transmitter module. You may want to change this if you are replacing an existing module for example. |
| <b>Configuration PIN</b> | This PIN will be required to configure this module.   |
| <b>View PIN</b>          | This PIN will be required to view the transmitted data from this module.  |



**Identification |  
Measurement |  
Calibration**

This is simply a menu/navigation mechanism to switch between the three pages that are available when configuring a Source.

# Configuration Measurement

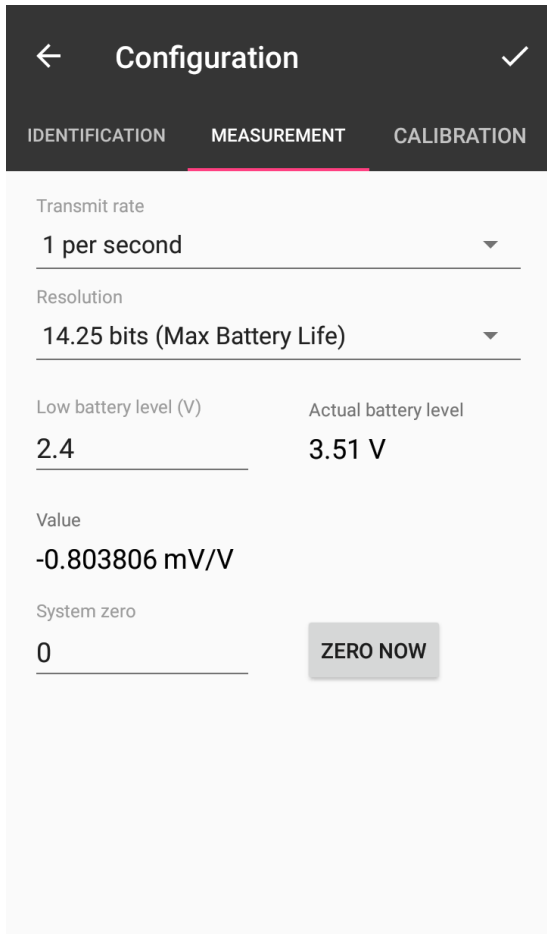

Android

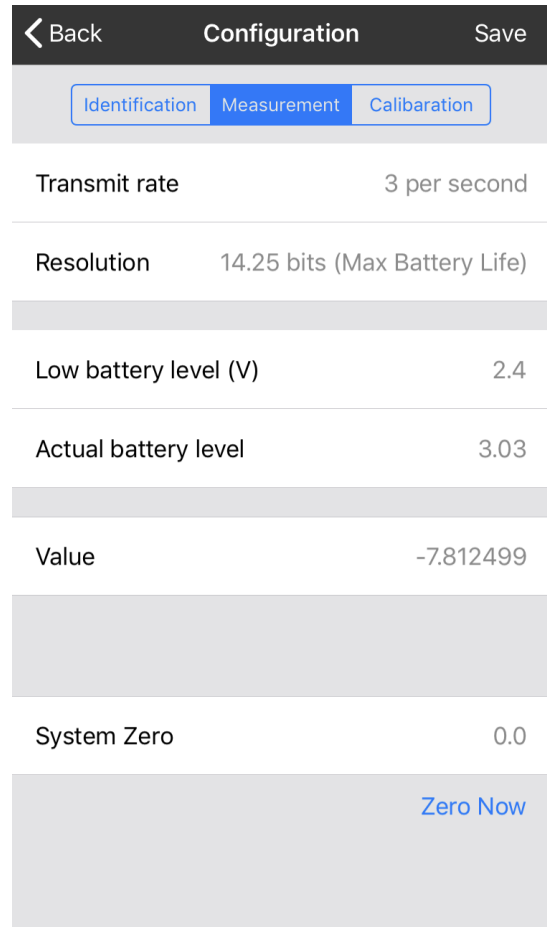

iOS

This page handles the measurement and transmission characteristics of the module.

## Controls and Actions:

Back

Cancel changes and go back to the previous page. Either [Find Transmitters](#) or [Linked Transmitters](#) page.

Save

OK – Finish editing, save and go back to the previous page. Either [Find Transmitters](#) or [Linked Transmitters](#) page.

### Transmit Rate

Select the rate at which the module will transmit data. The slower the transmission rate the better the battery life will be. Available options are: 1 every 10 seconds, 1 every 5 seconds, 1 every 2 seconds, 1 per second, 3 per second, 5 per second, 10 per second and Sleep.

### Resolution

Select the required noise free resolution. Higher resolution will result in the module spending longer averaging its input so will result in lower battery life. Options are: 14.25 bits (Max battery life), 15.25 bits (75% Battery Life), 16 bits (50% Battery Life), 16.5 bits (37% Battery Life) and 16.75 bits (30% Battery Life)

|   |  |
|---|--|
| <b>Low Battery Level</b>                                  | Set the voltage at which the module will indicate Low Battery.   |
| <b>Actual Battery Level</b>                               | Read-only value of the measured battery voltage.   |
| <b>Value</b>  | Shows the current value that will be transmitted. This value is the measured value minus the System Zero value.  |
| <b>System Zero</b>  | This shows, and allows you to set manually, the System Zero value. This value is subtracted from the measured value to create the transmitted value. This will have no effect unless a calibration has been performed. |
| <b>Zero Now Button</b>                                    | Tapping this will set the System Zero value so that the transmitted value will show zero with the currently applied input.   |
| <b>Identification  <br/>Measurement  <br/>Calibration</b> | This is simply a menu/navigation mechanism to switch between the three pages that are available when configuring a Source.   |

## Calibration Locked

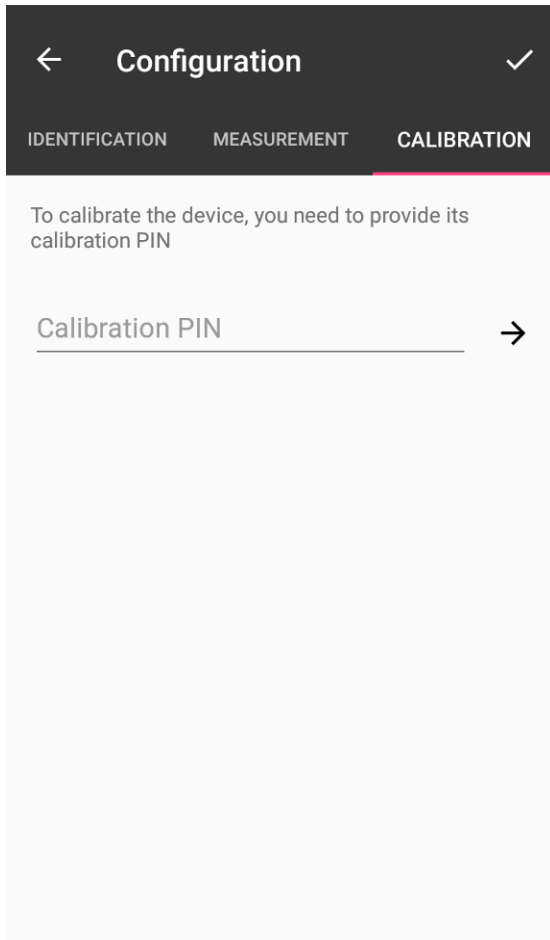

Android

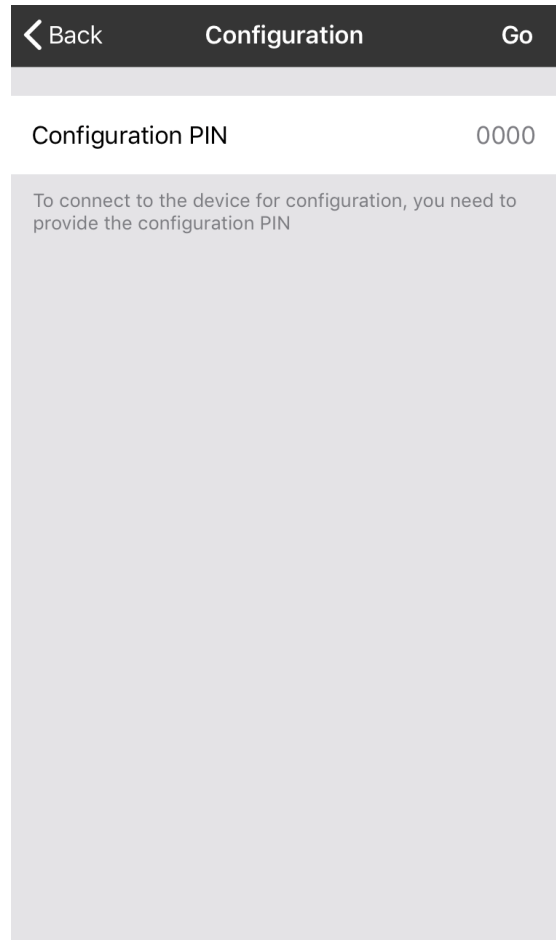

iOS

When tapping on the Calibration navigation from the previous page you will be presented with this screen if the Calibration PIN is set to anything other than the default 0000. You need to enter the correct Calibration PIN to be granted access to the calibration pages.

# Configuration Calibration Auto Calibration

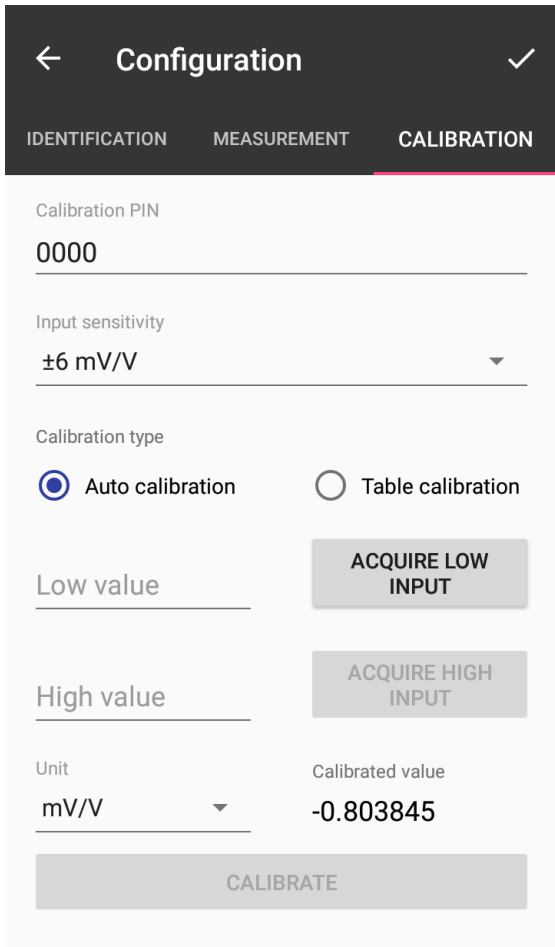

Android

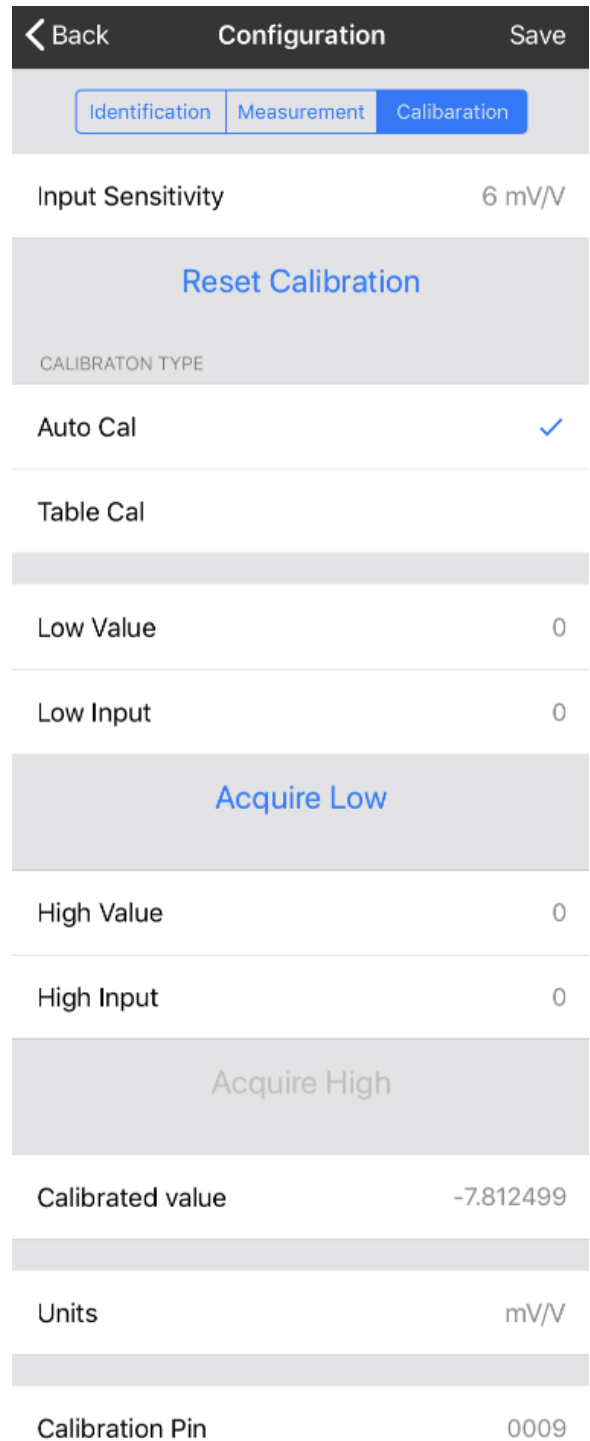

iOS

This page handles the calibration of the module. If the Calibration PIN of the module has been set to anything other than 0000 you will see the [Calibration Locked](#) page instead of this one. Calibration can be performed by Auto Calibration, where known weights are applied to the input, or by Table Calibration where known mV/V values are entered along with known weights (often found on the sensor calibration certificate). This page will describe the **Auto Calibration** technique.

## Controls and Actions:

y / <Back

Cancel changes and go back to the previous page. Either [Find Transmitters](#) or [Linked Transmitters](#) page.

p / Save

OK – Finish editing, save and go back to the previous page. Either [Find Transmitters](#) or [Linked Transmitters](#) page.

### Calibration PIN

If this is set to anything other than the default of 0000 then the user must enter the matching PIN in the app to gain access to this calibration page again.

### Input Sensitivity

Select the input range to best cover the intended sensor input range.



Changing this setting will require re-calibration!

### Low Value

Enter the required engineering low value. This is the known weight of the applied low input.

### Acquire Low Input

Apply the low input and tap the Acquire button once this has been given time to settle. The Acquire High Input button next to the High Input will now become enabled.

### High Value

Enter the required engineering high value. This is the known weight of the applied high input.

### Acquire High Input

Apply the high input value and tap the Acquire High Input button once this been given time to settle. Calibration will then take place.

### Units

Select the units that the module has been calibrated in.

### Calibration PIN

If you want to protect the calibration pages then enter a PIN other than 0000.

### Identification | Measurement | Calibration

This is simply a tab mechanism to switch between the three pages that are available when configuring a transmitter.



Note that even in connected mode the measurements are still only being taken at the Data Rate so time needs to be given between applying inputs and tapping the Calibrate button to allow the change in input to be reflected in the measurements.

If the module has already been calibrated you will see a Reset Calibration button on the screen which will revert the module to factory mV/V calibration.

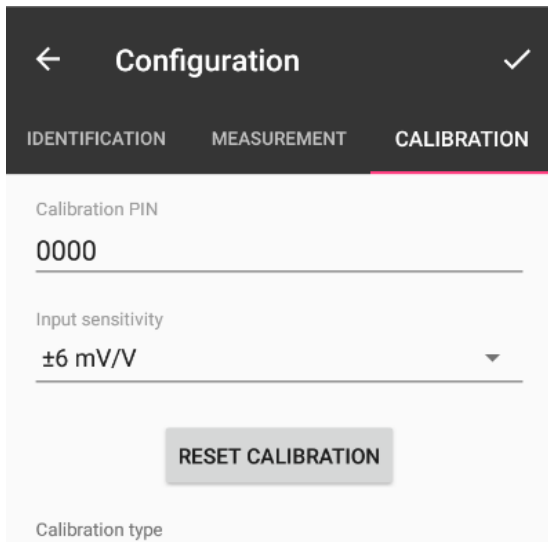

Android

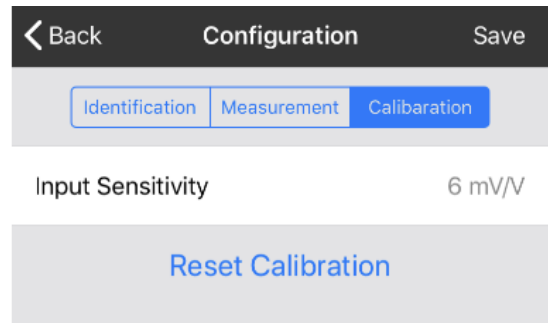

iOS

## Configuration Calibration Table Cal

← Configuration ✓

IDENTIFICATION MEASUREMENT **CALIBRATION**

Calibration PIN  
0000

Input sensitivity  
±6 mV/V

Calibration type  
 Auto calibration     Table calibration

Low input                      Low value

High input                      High value

Unit                              Calibrated value  
mV/V                              0.00018

CALIBRATE

Android

← Back Configuration Save

Identification Measurement **Calibration**

Input Sensitivity                      6 mV/V

Reset Calibration

CALIBRATION TYPE

Auto Cal

Table Cal                              ✓

Low Value                              0

Low Input                              0

High Value                              0

High Input                              0

Calibrated value                      -7.812499

Units                                      mV/V

Calibration Pin                      0009

Calibrate

To protect this calibration page you can enter a calibration Pin

iOS

This page handles the calibration of the module. If the Calibration PIN of the module has been set to anything other than 0000 you will see the [Calibration Locked](#) page instead of this one.

Calibration can be performed by Auto Calibration, where known weights are applied to the input, or by Table Calibration where known mV/V values are entered along with known weights (often found on the sensor calibration certificate). This page will describe the **Table Calibration** technique.



**Controls and Actions:**

y / <Back

Cancel changes and go back to the previous page. Either [Find Transmitters](#) or [Linked Transmitters](#) page.

p / Save

OK – Finish editing, save and go back to the previous page. Either [Find Transmitters](#) or [Linked Transmitters](#) page.

**Calibration PIN**

If this is set to anything other than the default of 0000 then the user must enter the matching PIN in the app to gain access to this calibration page again.

**Input Sensitivity**

Select the input range to best cover the intended sensor input range.



**Low Input**

Enter the mV/V input value for the low point.

**Low Value**

Enter the engineering unit value when the input is at the above entered level.

**High Input**

Enter the mV/V input value for the high point.

**High Value**

Enter the engineering unit value when the input is at the above entered level.

**Units**

Select the units that the module has been calibrated in

**Calibrated Value**

Displays the calibrated value that will be transmitted by the module.

**Calibrate Button**

Tap to perform the calibration.

**Identification |  
Measurement |  
Calibration**

This is simply a menu/navigation mechanism to switch between the three pages that are available when configuring a Source.

If the module has already been calibrated you will see a Reset Calibration button on the screen which will revert the module to factory mV/V calibration.

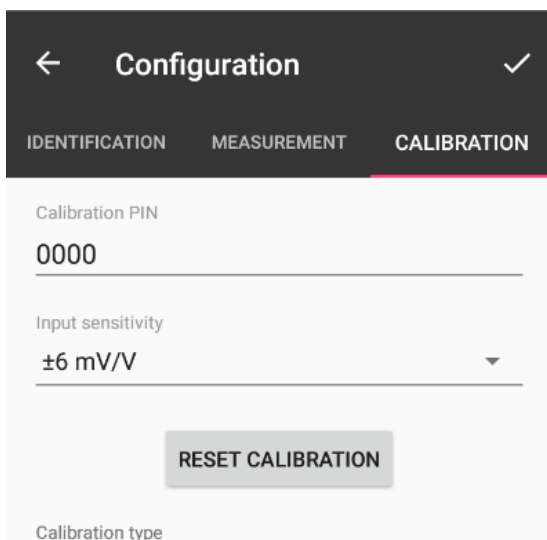

Android

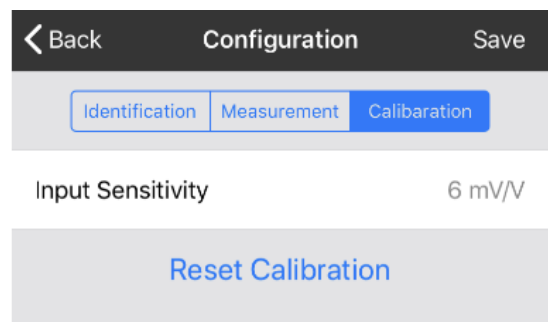

iOS

---

# Transmitter Modules

B24 Transmitters are the modules that connect to a sensor or have an input signal applied and periodically transmit messages containing the value read from the sensor or input.

---

## B24-SSBX-A, B24-SSBC-A

---

### Overview

The B24 product range currently consists of a housed and OEM version strain bridge input transmitter module.

---

### Order Codes

---

#### B24-SSBX-A



OEM strain transmitter module.

#### B24-SSBC-A



Strain transmitter module mounted in weatherproof enclosure with battery holder for two AA batteries

---

## Connections

---

### B24-SSBX-A

#### Power

Attach power supply wiring to the module as shown below:

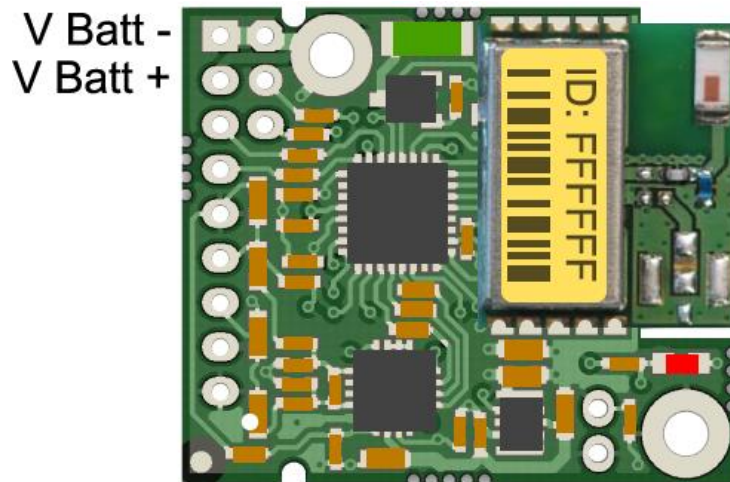

Battery Voltage should not exceed 3.75V. Care must be taken when charging secondary cells

---

#### Sensor

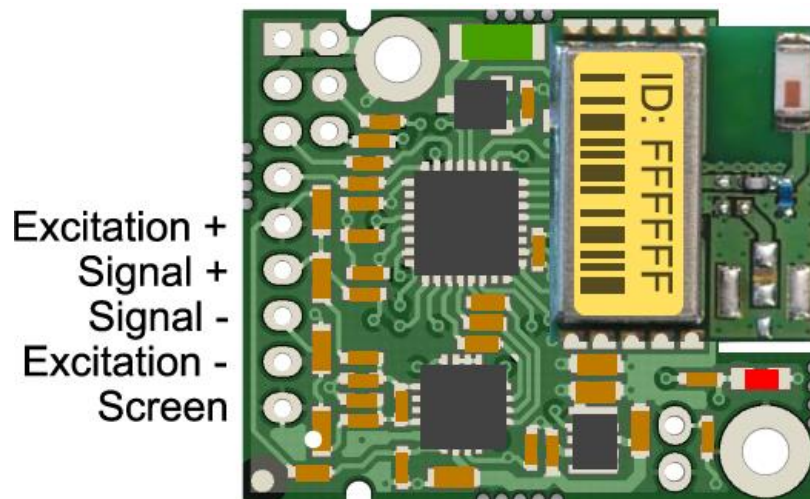

The resistance of the strain gauge can be between 85 and 5000 ohms. The B24-SSBX can support up to four 350 ohm strain gauges bridges attached in parallel (At the expense of reduced battery life).

The cable lengths between the B24-SSB and the gauges should be kept below 0.5 meters and generally as short as possible. As the measurement is a four wire connection, as the cable length increases the voltage drops in the cable will have more of an effect on the factory mV/V calibration.

The strain gauge measurement is bi-directional, i.e. tension & compression.

---

## Digital Connections

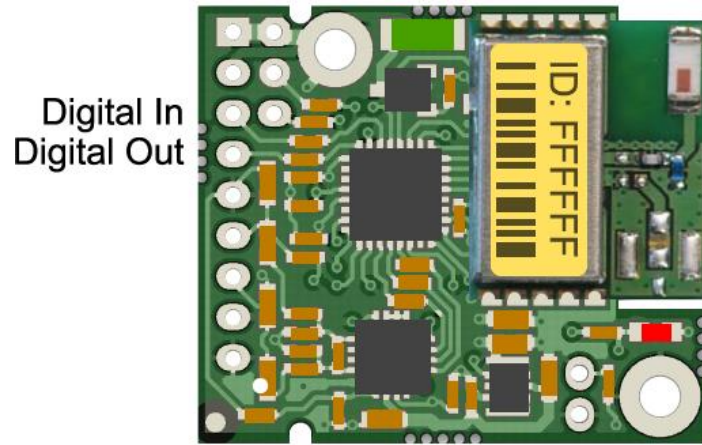

The digital input and output connections are shown above. The two digital lines provide a TTL input/output with a 1 k $\Omega$  input/output impedance respectively.

---

## Reset Communications

Shorting the two PTH holes during power up restores the communication characteristics as follows.

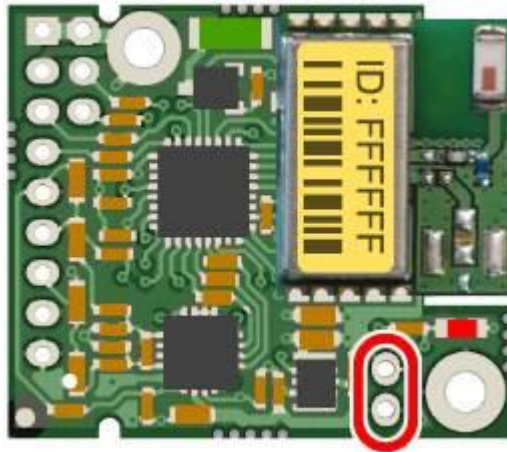

|                 |                            |
|-----------------|----------------------------|
| Name            | B24                        |
| DataTag         | Last four hex digits of ID |
| Calibration PIN | 0000                       |
| Data Rate       | 1 Second                   |
| Fast Mode       | Disabled                   |

---

## B24-SSBC-A

The B24-SSBC-A is the housed version of the B24 bridge acquisition module.

---

### Power

The enclosure is designed to accept two AA batteries. Maximum voltage 1.8 V per cell.  
For battery information please refer to [Appendix D – Battery Selection](#)

---

### Sensor

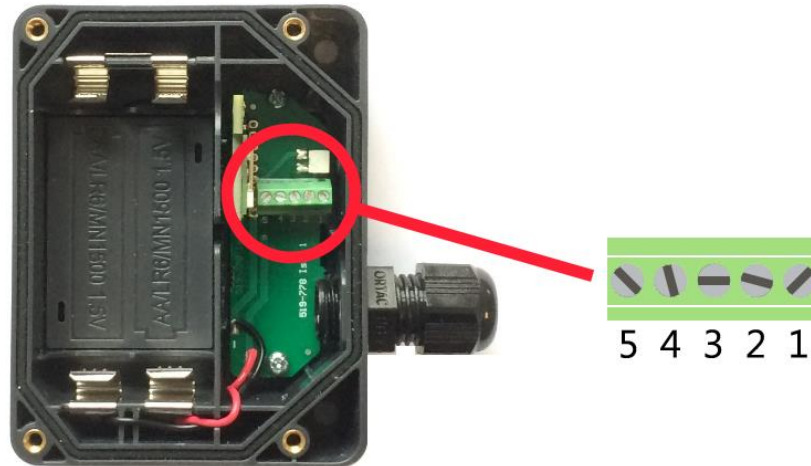

| Screw Terminal | Function                       |
|----------------|--------------------------------|
| 1              | Shield                         |
| 2              | - Excitation                   |
| 3              | -Signal                        |
| 4              | +Signal                        |
| 5              | + Excitation (Battery voltage) |

---

## Enclosure & Mounting

This module is available in a number of different enclosure types. Locate your module and follow the link to view dimensional and mounting information for that particular enclosure.

---

### B24-SSBX-A

These OEM modules are bare PCB modules. Please see [Appendix A – Enclosures & Mounting – OEM Transmitter Modules](#) for more information.

---

### B24-SSBC-A

This module is fitted inside our medium enclosure. Please see [Appendix A – Enclosures & Mounting – 'C' Style](#) for more information.

---

## Antennas

---

### B24-SSBX-A, B24-SSBC-A

This module uses an integrated chip antenna. See [Appendix B – Antennas](#)

## Specification

Specification with 1000R bridge, 2.5mV/V, at 3V supply at 25°C

| Measurement                        | Min            | Typical          | Max             | Units             |
|------------------------------------|----------------|------------------|-----------------|-------------------|
| Strain Gauge Excitation System     |                |                  | 4 Wire          |                   |
| Strain Gauge Excitation Voltage    | 2.3            | terminal Voltage | 3.75            | Vdc               |
| Strain Gauge Drive Capability      | 85             | -                | 5000            | Ω                 |
| Maximum Gauge Sensitivity (FR)     |                |                  | 48              | +/-mV/V           |
| Offset Temperature Stability       |                | ±5               |                 | ppm/°C            |
| Gain Temperature Stability         |                | 1                | 4               | ppm/°C            |
| Non Linearity before Linearisation |                | 6                | 15              | ppm of FR         |
| Internal Resolution                |                | 16,000,000 / 24  |                 | Resolution / Bits |
| Noise Free Resolution @ 2.5 mV/V   | 19,000 / 14.25 |                  | 110,000 / 16.75 | Resolution / Bits |

1. From original offset at any time.
2. First year.

| Environmental               | Min | Typical | Max | Units |
|-----------------------------|-----|---------|-----|-------|
| Operating temperature range | -40 |         | +85 | °C    |
| Storage Temperature         | -40 |         | +85 | °C    |
| Humidity                    | 0   |         | 95  | %RH   |

| Power Supply             | Min | Typical | Max  | Units       |
|--------------------------|-----|---------|------|-------------|
| Standby                  |     | 6       | 10   | μA          |
| Power Supply voltage     | 2.3 | 3.0     | 3.75 | Vdc         |
| Power Supply ripple      |     |         | 50   | mV ac pk-pk |
| Peak Current (1K Bridge) |     | 20      | 30   | mA          |

| Battery Life Generating Results at 1Hz with 1000 Ohm Load Cell | Usage         | Battery Life |
|--|---------------|--------------|
| Pair AA cells (3000 mAh)                                       | Constantly on | 10 months    |

# Power Supply Modules

## T24-BC1

### Overview

The T24-BC1 is a battery charger and power supply suitable for the 3V transmitter modules. The T24 Battery Charger is designed to supply a constant 3.3 V from a Li-ion Battery while also charging the battery from an input voltage. The unit comes pre-configured to provide a charging current of 466 mA suitable for VARTA LIP653450. This module also supports additional batteries providing a charge current of 133 mA via the removal of the leaded resistor (non surface mount).

### Physical Connections

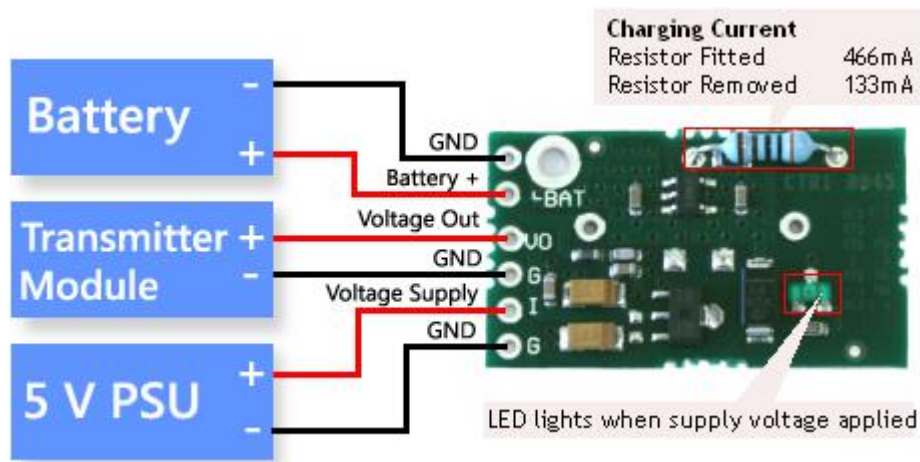

### Specification

| Parameter                   | Min | Typ | Max   | Units   |
|-----------------------------|-----|-----|-------|---------|
| Supply Voltage              | 4.1 | 5   | 6     | Vdc     |
| Regulated Voltage Output    | -   | 3.3 | -     | Vdc     |
| Battery positive connection | -   | 3.7 | -     | Vdc     |
| Maximum Cable Length        | -   | -   | 150 * | mm      |
| Quiescent Current           | -   | 1.7 | -     | $\mu$ A |

\* 07/02 gauge wire attached to maximum load i.e. B24 module with four 350 ohm strain gauges  
Note LED will only be lit when an input voltage is applied



---

# Appendices

---

## Appendix A - Enclosures

---

### OEM Transmitter Modules

---

#### Dimensions

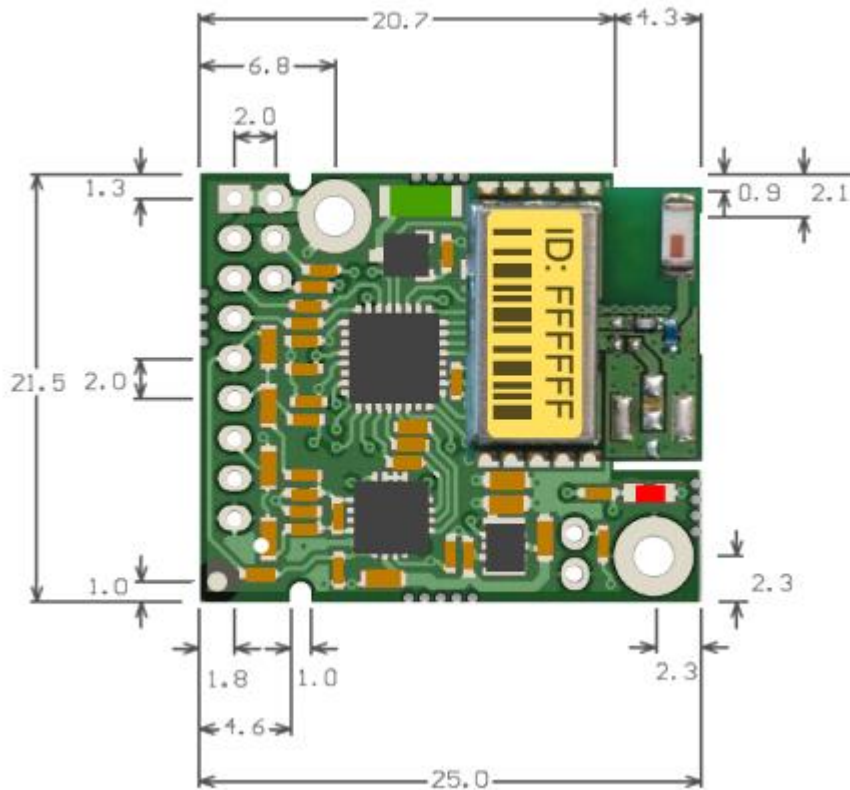

Height is 3.6 mm

---

#### Opening the Case

These modules are not housed in an enclosure.

---

#### Mounting Information

There are two holes available for mounting. Both location points can accept an M2 screw or American equivalent #0-80.

**!** DO NOT USE #2 screw size.

Note that the mounting hole is connected directly to the Battery ground of the transmitter module.

The connection header is a 2.0 mm pitch and a diameter of 1.0 mm.

---

## Antenna Position

The B24 product range uses an integral chip antenna. There should be no metallic (or RF conducting) material within 15 mm of the antenna. The use of metallic objects (including wires and enclosures) close to the area surrounding the antenna will degrade the transmission range.

---

## Environmental Protection

These modules are not protected against the environment.

---

## 'C' Type



---

### Dimensions

This enclosure is 79.5 mm X 62 mm (At the widest part of the lid) and 34 mm deep. The gland extends a further 25 mm from one long side.

---

### Opening the Case

The case lid is secured with 4 x #2 cross head screws, remove the four screws and lift lid.

---

### Mounting Information

The enclosure has two mounting holes as shown below; these mounting holes are external to the seal but still covered by the case lid to offer fixings for some environmental protection. In addition mountings can be made through the back of the case however a seal or gasket must be used to maintain environmental protection.

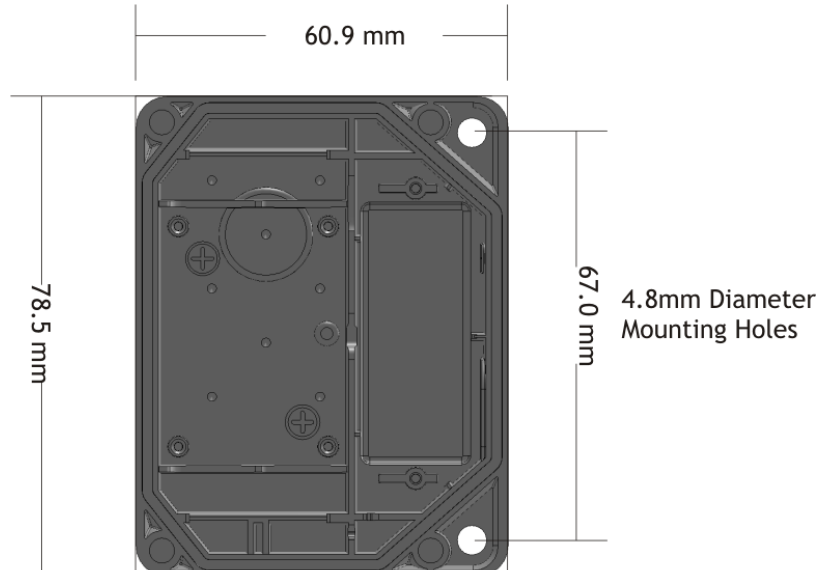

---

## Antenna Position

The module integral chip antenna is located near the centre of the enclosure close to the lid. There should be no metallic (or RF conducting) material within 15 mm of the antenna. The use of metallic objects (including wires and enclosures) close to the area surrounding the antenna will degrade the transmission range.

---

## Environmental Protection

The case is environmentally sealed to IP67 when the correct cable diameters are used.

The sealing gasket resides in the base. Be careful when replacing the lid that there are no dirt particles on the gasket channel or lid as this may reduce the sealing capability.

The cable diameter can range from 3.0 mm to 6.5 mm. Cables of a smaller diameter may be used if sleeved to increase their diameter.

When mounting the enclosure outside the cables should be dressed to provide a drip loop.

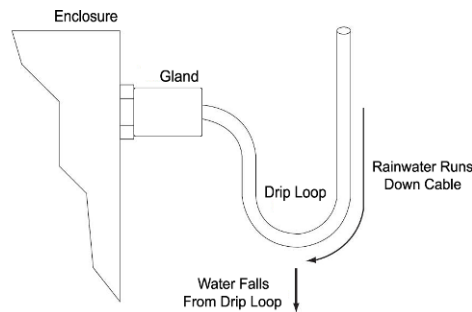

---

## Appendix B – Antennas

---

### B24-SSBX-A, B24-SSBC-A

Both modules use an integral chip antenna.

Radio performance at microwave wavelengths is very dependent upon the operating environment; any structure within the operating region of the radios will give rise to three effects:

**Obscuration.** Obscuration will result in reduced range and occurs when an obstruction masks the line-of-sight between radios.

**Aberrations to the horizontal and vertical space patterns.** Distortion of these patterns may occur if structures or objects are placed in the near or intermediate field of the antenna. The effect will be to distort the coverage patterns, adversely affecting range and link quality.

**Reflection.** Any object placed in line-of-sight of the transmit antenna will result in signals arriving at the receiver by an indirect path. Degradation of performance due to reflection (multipath effects) appears as reduced range or poor link quality.

Any of the above will reduce RSSI figures, an increase in the packet loss rate and in extreme cases complete loss of signal. Fortunately, if consideration is given to these effects at the integration stage then a good quality link will be obtained.

#### **Guidelines for product design:**

When selecting materials for product enclosures, preference should be given to fibreglass, light coloured ABS or Polypropylene (Dark colours can sometimes be achieved with the addition of carbon which can attenuate the radio signal); at the wavelength of 2.4GHz radio other materials will adversely affect the signal by attenuation, refraction or change in polarisation.

If the application demands that the radio is fitted inside a metal enclosure then ensure that the specified clearances are maintained around the antenna and design in a fibreglass RF window at least as large as the clearance dimensions but ideally as large as possible.

#### **Guidelines for installation:**

When planning installations ensure that line-of-sight between nodes is maintained and that objects or structures are kept at least one metre away from antennae wherever possible.

Improvement will also be obtained by altering the height above ground of the B24 transmitter; a small increase in antenna elevation will often improve reception.

---

## Internal Chip Antenna (OEM Modules)

This is a helix type surface mount ceramic chip antenna.



Ideally the product enclosure should be made from fibreglass, light coloured ABS or Polypropylene; other materials may adversely affect the signal by attenuation, refraction or change in polarisation.

---

## Mounting

If the application demands that the radio is fitted inside a metal enclosure then ensure that the specified clearances are maintained around the antenna and design in a fibreglass RF window at least as large as the clearance dimensions but ideally as large as possible.

Radio modules fitted inside a product should be oriented so that the chip antenna will be vertical when the product is in its normal operating position.

There must be no metal objects within 15 mm radius of the antenna edges.

---

## Antenna Range

The achievable range in the B24 module is heavily dependent upon the Bluetooth Low Energy receiver. Each mobile platform manufacturer specify different limits on the receive sensitivity of their hardware. In our tests the Apple products achieved the best range. Mobile phones less than two years old exhibit a range of between 50 and 90 metres line of sight. Table 1 gives the maximum range in an open field site between a B24 transmitter module and specific mobile phones. All range tests are conducted in an open field site with the transmitter mounted 3.0 metres off the ground on a plastic pole. The mobile receiver was held at 1.5m off the ground directed towards the transmitter.

The testing conducted shows a trend towards an improved range as the Bluetooth low energy technology has matured on the mobile devices.

| Bluetooth Low Energy Receiver | Transmission Distance | Year of Release |
|-------------------------------|-----------------------|-----------------|
| Apple iPhone 7                | > 90 m                | 2016            |
| Apple iPhone 5s               | 65 m                  | 2013            |
| Samsung Galaxy S6             | 65 m                  | 2015            |
| HTC One m8                    | 25 m                  | 2014            |
| HTC One m7                    | 25 m                  | 2013            |

**Table 1:** B24 Transmission range

---

## Appendix C - Radio Specification

---

### Bluetooth certification

The module with embedded stack and profile has been qualified in accordance with SIG qualification rules:

- Declaration ID: D028766
- Qualified design ID: 71984
- Product type: End Product
- Core spec version: 4.1
- Product description: Bluetooth Smart v4.1 module



---

## Appendix D – Battery Selection

The following section applies to transmitter modules. Some enclosures will determine the battery type and size.

---

### Considerations When Selecting Batteries

---

#### Re-chargeable or replacement

This really depends on the application. Some applications where expected battery life with alkaline batteries will be many years would probably not warrant the use of re-chargeable batteries. Re-chargeable batteries have implementation issues such as how to connect to the charger, how to seal this connection if required, can the batteries be re-charged at a convenient point in the operation of the module i.e. between shifts and does the voltage, when charging, exceed the maximum supply voltage of the transmitter module if so the inline charging module will need to be fitted.

---

#### Required battery life

Driven by the application and mainly dependent on measurement rate and sample time. The operation would normally require that the transmitter module is used in Low Power Mode to maximise battery life.

---

#### Size of

Choosing a battery will be influenced by how much space is available and what battery life is required, generally the bigger the battery the longer it will last.

---

#### Operating temperature range

A battery's useable capacity is influenced by its operating temperature. Generally, the lower the temperature the lower their ability to provide charge. Beware of the batteries specified operating range when considering a particular battery technology.

---

#### Self-discharge.

Batteries are chemical devices and have a shelf life which needs to be considered in application where long battery life is required. Typically an Alkaline has a battery life of 5 years.

---

#### Connections to battery

If sourcing battery holders for OEM transmitter modules be aware that some holders with springs only on one side of the battery can temporarily disconnect a battery when subjected to a shock force. This may have the unexpected effect of resetting a module. In the case of a B24 module that is connected via Bluetooth then this connection may be dropped.

---

#### Environmental

Other considerations when selecting a connection method to the Batteries is the effect of vibration. A standard battery holder is a poor choice in applications when the module can be subject to vibration. This is due to the interruption of supply from the battery to the transmitter module caused when the spring arrangement holding the battery to the terminal of the holder is defeated.

Corrosion of terminals must also be considered as this will also introduce resistance into the supply connections. This could be overcome by ensuring the enclosure is sealed.

---

---

## Optimising battery life

Battery life can be optimised by considering the following:

- Transmission interval.
- Required Measurement resolution (Sample time).

---

## Battery Types

| Battery Type                                    | Notes   |
|---|---|
| Lithium Iron Disulphide<br>Li-FeS <sub>2</sub>  | These can be found at 1.5 volts in AA size and can therefore be a direct replacement for Alkaline cells. The low internal resistance and high capacity make these batteries an ideal choice. The shelf life is around 20 years.<br>Recommended for AA battery powered modules: <b>Energizer Ultimate Lithium L91</b>  |
| Alkaline<br>Zn-MnO <sub>2</sub>                 | Pairs of alkaline 1.5 V cells are the most common. Use D cells for maximum life and AA cells where space is restricted. Typical capacity is 2Ah.<br>Example: Varta 4014 (D), Varta 4006 (AA)  |
| Nickel Metal Hydride<br>NiMh                    | Most cells are 1.2 V so two in series gives 2.4 V. These can match alkaline batteries in capacity but as the charged voltage is lower they do not match the usable capacity. These batteries self discharge at a faster rate than alkalines. If charging these cells in circuit precautions must be taken to ensure that the maximum voltage on the transmitter module is not exceeded.<br>Example: GP 270AAHC (AA) |
| Nickel Cadmium<br>NiCad                         | Most cells are 1.2 V so two in series gives 2.4 V. Three in series can be used to give 3.6 volts. These do not have the usable capacity of an alkaline battery. These are generally only useful if they are to be charged on a regular basis. If charging these cells in circuit precautions must be taken to ensure that the maximum voltage on the transmitter module is not exceeded.                            |
| Lithium Primary 3.6V<br>Li-SOCl <sub>2</sub>    | Lithium cells can be used but note that the absolute maximum voltage is 3.75 V. Select a cell with low internal resistance.<br>Example: Saft LS17500 (A), Saft LSH20 (D)<br><b>Recommend B24-BC1 module</b> as these cells usually have a high internal resistance.   |
| Lithium Ion and Lithium Polymer<br>Li ion, LiPo | These generally start at 3.7 V and exceed the maximum allowable voltage. These are usable if a regulator and charging circuit can be installed between the transmitter module and the battery. Care must be taken here that the regulator does not draw too much current when idle so that the low power modes are not compromised.<br><b>Recommend B24-BC1 module.</b>   |

## Battery Life Guide

The following table offers a guide to expected battery life with the module running at different Data Rates and Resolution settings using 2 X AA **Energizer L91** Batteries 3000mAh Capacity with a 1000 ohm load cell.

|           |                    | Resolution |            |           |            |            |
|-----------|--------------------|------------|------------|-----------|------------|------------|
|           |                    | 14.25 bits | 15.25 bits | 16 bits   | 16.5 bits  | 16.75 bits |
| Data Rate | 1 every 10 seconds | 8 years    | 6.5 years  | 4.5 years | 3.5 years  | 3 years    |
|           | 1 every 5 seconds  | 4 years    | 3 years    | 2 years   | 1.5 years  | 1 year     |
|           | 1 every 2 seconds  | 20 months  | 16 months  | 11 months | 8 months   | 6 months   |
|           | 1 per second       | 10 months  | 8 months   | 5 months  | 4 months   | 3 months   |
|           | 3 per second       | 3.5 months | 2.5 months | 2 months  | 1.5 months | 1 month    |
|           | 5 per second       | 2 months   | 1.5 months | 1 month   | 26 days    | 21 days    |
|           | 10 per second      | 1 month    | 24 days    | 17 days   | 13 days    | 10 days    |
|           | Sleep              | >10 years  |            |           |            |            |

**i** NOTE: Using **Varta CR2032** cell with a 1000 ohm load cell at 14.25 bits with a transmission rate of 3 per second we can achieve 8 days operation.

---

## Appendix E – Approval Statements

Bluetooth® low energy v4.1

For radio range information See [Appendix B – Antenna Range](#)

---

### Certifications

---

#### Bluetooth certification

The module with embedded stack and profile has been qualified in accordance with SIG qualification rules:

- Declaration ID: D028766
  - Qualified design ID: 71984
  - Product type: End Product
  - Core spec version: 4.1
  - Product description: Bluetooth low energy v4.1 module
- 

#### CE Certification



Complies with EMC directive. 2014/30/EU  
The Radio Equipment Directive, 2014/53/EU,

#### European Community, Switzerland, Norway, Iceland, and Liechtenstein

|              |   |
|--------------|---|
| English:     | This equipment is in compliance with the essential requirements and other relevant provisions of Directive 1999/5/EC.       |
| Deutsch:     | Dieses Gerät entspricht den grundlegenden Anforderungen und den weiteren entsprechenden Vorgaben der Richtlinie 2014/53/EU. |
| Dansk:       | Denne udstyr er i overensstemmelse med de væsentlige krav og andre relevante bestemmelser i Direktiv 2014/53/EU.            |
| Español:     | Este equipo cumple con los requisitos esenciales así como con otras disposiciones de la Directiva 2014/53/EU.               |
| Français:    | Cet appareil est conforme aux exigences essentielles et aux autres dispositions pertinentes de la Directive 2014/53/EU.     |
| Íslenska:    | Þessi búnaður samrýmist lögboðnum kröfum og öðrum ákvæðum tilskipunar 2014/53/EU.   |
| Italiano:    | Questo apparato é conforme ai requisiti essenziali ed agli altri principi sanciti dalla Direttiva 2014/53/EU.               |
| Nederlands:  | Deze apparatuur voldoet aan de belangrijkste eisen en andere voorzieningen van richtlijn 2014/53/EU.                        |
| Norsk:       | Denne utstyret er i samsvar med de grunnleggende krav og andre relevante bestemmelser i EU-direktiv 2014/53/EU.             |
| Português:   | Este equipamento satisfaz os requisitos essenciais e outras provisões da Directiva 2014/53/EU.                              |
| Suomalainen: | Tämä laite täyttää direktiivin 2014/53/EU oleelliset vaatimukset ja on siinä asetettujen muidenkin ehtojen mukainen.        |
| Svenska:     | Denna utrustning är i överensstämmelse med de väsentliga kraven och andra relevanta bestämmelser i Direktiv 2014/53/EU.     |

This equipment is in compliance with the essential requirements and other relevant provisions of Directive 2014/53/EU.

**Manufactured in the UK by: Mantracourt Electronics Ltd, The Drive, Farringdon, Exeter, Devon, EX5 2JB, UK**

---

## CE certification for SPBTLE-RF module

The SPBTLE-RF module has been certified according to the following standards:

- EN 60950-1:2006 + A11:2009 + A12:2011 + A1:2010 + A2:2013 + AC:2011
- ETSI EN 301 489-1 V2.1.1 (2017-02)
- ETSI EN 301 489-17 V3.1.1 (2017-02)
- ETSI EN 300 328 V1.8.1:2012
- ETSI EN 300 328 V2.1.1 (2016-11)
- EN62479:2010

CE Expert opinion: 0561-ARSP00053

The module has obtained the RED certificate: No. 0051-RED-0011 REV. 0

The module is CE certified:

**CE0051**

---

## FCC Certification

- This device complies with Part 15 of the FCC Rules. Operation is subject to the following two conditions:
  - (1) This device may not cause harmful interference, and
  - (2) This device must accept any interference received, including interference that may cause undesired operation.
- This equipment complies with FCC radiation exposure limits set forth for an uncontrolled environment. End users must follow the specific operating instructions for satisfying RF exposure compliance. This transmitter must not be co-located or operating in conjunction with any other antenna or transmitter.
- Changes or modifications not expressly approved by the party responsible for compliance could void the user's authority to operate the equipment

**Manufactured in the UK by: Mantracourt Electronics Ltd, The Drive, Farringdon, Exeter, Devon, EX5 2JB, UK**

---

## FCC Modular approval

FCC ID: S9NSPBTLERF

In accordance with FCC part 15, the SPBTLE-RF is listed as a modular transmitter device.

This module is evaluated for stand-alone use only. Finished products incorporating multiple transmitters must comply with colocation and RF exposure requirements in accordance with FCC multi-transmitter product procedures. Collocated transmitters operating in portable RF Exposure conditions (e.g. <20 cm from persons including but not limited to body worn and hand held devices) may require separate approval.

---

## IC Certification

The SPBTLE-RF module has been tested and found compliant with the IC RSS-210 rules.

These limits are designed to provide reasonable protection against harmful interference in approved installations.

This equipment generates, uses, and can radiate radio frequency energy and, if not installed and used in accordance with the instructions, may cause harmful interference to radio communications.

However, there is no guarantee that interference may not occur in a particular installation.

This device complies with RSS-210 of the IC rules. Operation is subject to the following two conditions:

1. this device may not cause harmful interference,  
and
  2. this device must accept any interference received, including interference that may cause undesired operation.
- Modifications or changes to this equipment not expressly approved by STMicroelectronics may render void the user's authority to operate this equipment.

**Manufactured in the UK by: Mantracourt Electronics Ltd, The Drive, Farringdon, Exeter, Devon, EX5 2JB, UK**

---

## IC Modular approval

IC: 8976C-SPBTLERF

In accordance with IC RSS-210, the SPBTLE-RF is listed as a modular transmitter device.

This module is evaluated for stand-alone use only. Finished products incorporating multiple transmitters must comply with collocation and RF exposure requirements in accordance with IC multi-transmitter product procedures. Collocated transmitters operating in portable RF Exposure conditions (e.g. <20cm from persons including but not limited to body worn and hand held devices) may require separate approval.

---

## TELEC certification

The SPBTLE-RF module has been tested according to following TELEC certification rules:

Type of specified radio equipment

- Radio equipment according to certification ordinance article 2-1-9

Sophisticated low power radio data communication system in 2.4 GHz band.

Class of emissions, assigned frequency, and antenna power

- F1D, G1D 2441 MHz channel separation 2 MHz/40 channel, 0.0025 W

Certification number

- 006-000395

Design and manufacturing are certified based on Japan radio law 38-24.

---

## OEM / Reseller Marking and Documentation Requirements

---

### CE Labelling Instructions

The B24 series has been certified for several European countries.

If the transmitter module is incorporated into a product, the manufacturer must ensure compliance of the final product to the European harmonized EMC and low-voltage/safety standards. A Declaration of Conformity must be issued for each of these standards and kept on file as described in Annex II of the R&TTE Directive.

Furthermore, the manufacturer must maintain a copy of the B24 device user manual documentation and ensure the final product does not exceed the specified power ratings, antenna specifications, and/or installation requirements as specified in the user manual. If any of these specifications are exceeded in the final product, a submission must be made to a notified body for compliance testing to all required standards.

### OEM Labelling Requirements

The 'CE' marking must be affixed to a visible location on the OEM product.

The CE mark shall consist of the initials "CE" taking the following form:

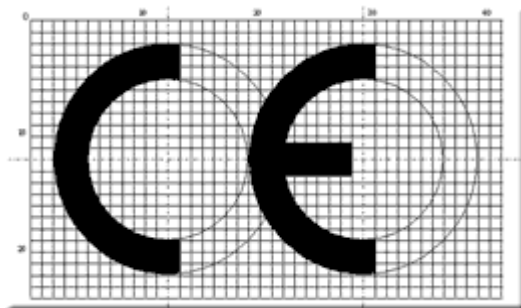

- If the CE marking is reduced or enlarged, the proportions given in the above drawing must be respected.
- The CE marking must have a height of at least 5 mm except where this is not possible on account of the nature of the apparatus.
- The CE marking must be affixed visibly, legibly, and indelibly.

---

### FCC Labeling Instructions

When integrating the B24 OEM module into the final product, the OEM must ensure that the FCC labelling requirements are satisfied. A statement must be included on the exterior of the final product which indicates the

product includes a certified module. The label should state the following (or similar wording that conveys the same meaning):

The OEM must include the following statements on the exterior of the final product unless the product is too small (e.g. less than 4 x 4 inches):

This device complies with Part 15 of the FCC Rules. Operation is subject to the following two conditions:

Contains FCC ID: S9NSPBTLERF

OR

This product contains FCC ID: S9NSPBTLERF

1. this device may not cause harmful interference,  
and

2. this device must accept any interference received, including any interference that may cause undesired operation.

---

## FCC Product Manual Instructions

This section applies to OEM final products containing the B24 module, subject to FCC compliance. The final product manual must contain the following statement (or a similar statement that conveys the same meaning):

**Warning: Changes or modifications not expressly approved by the party responsible for compliance could void the user's authority to operate the equipment. (Part. 15.21)**

In the case where an OEM seeks Class B (residential) limits for the final product, the following statement must be included in the final product manual:

*Note: This equipment has been tested and found to comply with the limits for a Class B digital device, pursuant to part 15 of the FCC Rules. These limits are designed to provide reasonable protection against harmful interference in a residential installation. This equipment generates, uses and can radiate radio frequency energy and, if not installed and used in accordance with the instructions, may cause harmful interference to radio communications. However, there is no guarantee that interference will not occur in a particular installation. If this equipment does cause harmful interference to radio or television reception, which can be determined by turning the equipment off and on, the user is encouraged to try to correct the interference by one or more of the following measures:*

- Reorient or relocate the receiving antenna.
- Increase the separation between the equipment and receiver.
- Connect the equipment into an outlet on a circuit different from that to which the receiver is connected.
- Consult the dealer or an experienced radio/TV technician for help.

In the case where an OEM seeks the lesser category of a Class A digital device for the final product, the following statement must be included in the final product manual:

*Note: This equipment has been tested and found to comply with the limits for a Class A digital device, pursuant to part 15 of the FCC Rules. These limits are designed to provide reasonable protection against harmful interference when the equipment is operated in a commercial environment. This equipment generates, uses, and can radiate radio frequency energy and, if not installed and used in accordance with the instruction manual, may cause harmful interference to radio communications. Operation of this equipment in a residential area is likely to cause harmful interference in which case the user will be required to correct the interference at his expense.*

---

## IC Labeling Instructions

When integrating the SPBTLE-RF into the final product, the OEM must ensure that the IC labeling requirements are satisfied. A statement must be included on the exterior of the final product which indicates that the product includes a certified module. The label should state the following (or similar wording that conveys the same meaning):

The OEM must include the following statements on the exterior of the final product unless the product is too small (e.g. less than 4 x 4 inches):

This device complies with RSS-210 of the IC Rules. Operation is subject to the following two conditions:

1. this device may not cause harmful interference,  
and

2. this device must accept any interference received, including any interference that may cause undesired operation.

Contains IC: 8976C-SPBTLERF

OR

This product contains IC: 8976C-SPBTLERF



---

## IC Product Manual Instructions

This section applies to OEM final products containing the SPBTLE-RF module, subject to IC compliance. The final product manual must contain the following statement (or a similar statement that conveys the same meaning):

**Warning: Changes or modifications not expressly approved by the party responsible for compliance could void the user's authority to operate the equipment. (RSS-210)**

In the case where an OEM seeks Class B (residential) limits for the final product, the following statement must be included in the final product manual:

*Note: This equipment has been tested and found to comply with the limits for a Class B digital device, pursuant to RSS-210 of the IC Rules. These limits are designed to provide reasonable protection against harmful interference in a residential installation. This equipment generates, uses and can radiate radio frequency energy and, if not installed and used in accordance with the instructions, may cause harmful interference to radio communications. However, there is no guarantee that interference will not occur in a particular installation. If this equipment does cause harmful interference to radio or television reception, which can be determined by turning the equipment off and on, the user is encouraged to try to correct the interference by one or more of the following measures:*

- Reorient or relocate the receiving antenna.
- Increase the separation between the equipment and receiver.
- Connect the equipment into an outlet on a circuit different from that to which the receiver is connected.
- Consult the dealer or an experienced radio/TV technician for help.

In the case where an OEM seeks the lesser category of a Class A digital device for the final product, the following statement must be included in the final product manual:

*Note: This equipment has been tested and found to comply with the limits for a Class A digital device, pursuant to RSS-210 of the IC Rules. These limits are designed to provide reasonable protection against harmful interference when the equipment is operated in a commercial environment. This equipment generates, uses, and can radiate radio frequency energy and, if not installed and used in accordance with the instruction manual, may cause harmful interference to radio communications. Operation of this equipment in a residential area is likely to cause harmful interference in which case the user will be required to correct the interference at his expense.*

---

## Appendix G - Worldwide Regional Approvals

| <b>Region</b> | <b>Product Conforms To</b> |
|---------------|----------------------------|
| Europe        | CE                         |
| USA           | FCC                        |
| Canada        | IC                         |
| Japan         | TELEC                      |

---

### Important Note

Mantracourt does not list the entire set of standards that must be met for each country. Mantracourt customers assume full responsibility for learning and meeting the required guidelines for each country in their distribution market.

For more information relating to European compliance of an OEM product incorporating the B24 range of modules, contact Mantracourt, or refer to the following web site: <https://www.cept.org/ecc>

## Appendix H - Declaration of Conformity

### EU DECLARATION OF CONFORMITY

We, the undersigned:



Name of Manufacturer:

**Mantracourt Electronics Ltd**

Address:

**The Drive, Farrington, Exeter, Devon,  
EX5 2JB**

Country:

**United Kingdom**

Declare under our sole responsibility that the **B24 Telemetry Product Range** is in conformity with the following relevant Union harmonisation legislation:

**Radio Equipment Directive 2014/53/EU  
EMC Directive 2014/30/EU**

**RoHS Directive 2011/65/EU**

Based on the following harmonised standards:

**EN 61326-1:2013  
EN 61326-2-3:2013**

**EN 300328 V1.9.1**

The SPBTLE-RF Bluetooth module has been certified according to the following standards:

**EN62479:2010  
ETSI EN 301 489-1 V1.9.2:2011  
ETSI EN 301 489-17 V2.2.1**

**ETSI EN 300 328 V1.8.1:2012  
ETSI EN 300 328 V1.9.1 (2015)  
EN 60950-1:2006 + A11:2009 + A12:2011  
+ A1:2010 + A2:2013 + AC:2011**

CE Expert opinion: **0561-ARSP00053**

The module is CE certified: **C0051**

Name and position of person binding the manufacturer or authorised representative:

Signed

Name: **Robert Willmington-Badcock**

Function: **Managing Director**

Location: **Mantracourt Electronics Ltd**

Date of issue: **16<sup>th</sup> January 2019**

Contains: FCC ID: S9NSPBTLERF IC: 8976C-SPBTLERF



### Warranty

All Telemetry products from Mantracourt Electronics Ltd., ('Mantracourt') are warranted against defective material and workmanship for a period of one (1) year from the date of dispatch.

If the 'Mantracourt' product you purchase appears to have a defect in material or workmanship or fails during normal use within the period, please contact your Distributor, who will assist you in resolving the problem. If it is necessary to return the product to 'Mantracourt' please include a note stating name, company, address, phone number and a detailed description of the problem. Also, please indicate if it is a warranty repair.

The sender is responsible for shipping charges, freight insurance and proper packaging to prevent breakage in transit.

'Mantracourt' warranty does not apply to defects resulting from action of the buyer such as mishandling, improper interfacing, operation outside of design limits, improper repair or unauthorised modification.

No other warranties are expressed or implied. 'Mantracourt' specifically disclaims any implied warranties of merchantability or fitness for a specific purpose.

The remedies outlined above are the buyer's only remedies. 'Mantracourt' will not be liable for direct, indirect, special, incidental or consequential damages whether based on the contract, tort or other legal theory.

Any corrective maintenance required after the warranty period should be performed by 'Mantracourt' approved personnel only.



Document Title: **B24 Telemetry User Manual**  
Applies To: **B24 Product Range**  
Part Number: **517-943**  
Issue Number: **01.06**  
Dated: **31<sup>st</sup> July 2020**

*In the interests of continued product development, Mantracourt Electronics Limited reserves the right to alter product specifications without prior notice.*



[www.mantracourt.com](http://www.mantracourt.com)